



FÜHRER

GROUP

2024



BİZ

Traktör, römork ve dorse ekipmanları üretiminde, Führer olarak sektörde kalitenin standartlarını belirleyen ve takip edilen olmaktan gurur duyuyoruz. Ar-Ge odaklı yenilikçi üretim anlayışımızla sürekli gelişiyor ve hızlı bir yükseliş grafiği sergiliyoruz. Konya 5. Organize sanayi bölgesindeki 25.000'i kapalı olmak üzere, toplam 38.000 m² alanda enerji dolu dinamik bir ekiple faaliyetimize devam ediyoruz ve traktör orta kol lifti, traktör direksiyon lifti ve özel amaçlı tarım liftleri başta olmak üzere geniş bir ürün yelpazesıyla müşterilerimize hizmet veriyoruz. Ürettiğimiz dayanıklı, uzun ömürlü yüzlerce ürünü, yüksek teknoloji ile donatılmış, seri üretim hattımızda üretiyor ve tüketiciyle buluşturuyoruz. Güncel Cad-Cam yazılımlarıyla tasarlanan ürünlerimiz, en iyi dayanıklılık sonucunu veren hammaddeler tercih edilerek üretime alınır ve CNC tabanlı tezgahlarımızda elmas hassasiyetinde işlenir. Döküm ve plastik enjeksiyon hattında üretilen parçalarla montajlanan ürünlerimiz, dünya standartlarında bir çok testten geçirilerek sevkiyata hazır hale getirilir. Üretim hattımız ve ürünlerimizin kalitesi CE, ISO ve TSE standartlarıyla güvence altına alınmıştır. Führer, inovasyon altyapısına sahip üretim anlayışıyla müşterilerinin ihtiyaçlarına maksimum seviyede cevap verebilecek kabiliyete sahiptir. Ürün Tasarımı konusundaki becerilerimiz, maliyet, üretim süresi, ömür, kolay revizyonlar açısından avantaj sağlamaktadır. Führer olarak, geçmişten gelen tecrübemizi, günümüz teknolojiyle birleştirerek sizlere her gün daha iyiye ulaşmanın gayreti içindeyiz.

FÜHRER TRAKTÖR VE RÖMORK EKİPMANLARI

US

In the production of tractor, trailer and trailer equipment, as Führer we are proud to be the one who sets and follows the standards of quality in the sector. With our R&D-oriented innovative production approach, we are constantly developing and exhibiting a rapid rise graph. Konya 5. We continue our activities with a dynamic team full of energy on a total area of 38.000 m², 25.000 of which are closed in the organized industrial zone, and we serve our customers with a wide range of products, especially tractor middle arm lift, tractor steering lift and special purpose agricultural lifts. We produce hundreds of durable, long-lasting products in our mass production line equipped with high technology and bring them to the consumer. Our products, which are designed with up-to-date Cad-Cam software, are taken into production by choosing raw materials that give the best durability result and processed with diamond precision in our CNC-based machines. Our products, which are assembled with parts produced in the casting and plastic injection line, are made ready for shipment by passing many tests at world standards. The quality of our production line and products is guaranteed by CE, ISO and TSE standards. The Führer has the ability to respond to the needs of its customers at the maximum level with its production approach with innovation infrastructure. Our skills in Product Design provide advantages in terms of cost, production time, life, easy revisions. As Führer, we are in an effort to reach you better every day by combining our experience from the past with today's technology.

FÜHRER TRACTOR AND TRAILER EQUIPMENTS

“

Liderlik,
ürün ve üretiminin
müşteri tarafından
takdir edilmesidir.

Leadership is the apprecia-
tion of the product and its
production by the customer.

ŞİRKET DEĞERLERİMİZ

Our Values



ZAMAN YÖNETİMİ / Time Management

Zaman yönetmek demek en kısa süre-
de müşterinin ihtiyacı olan ürünü en
iyi kalitede üretilip ulaştırmaktır.

Managing time means producing and
delivering the product that the custo-
mer needs in the shortest time with
the best quality.



EKİP YÖNETİMİ / Team Management

Ekip yönetimi, ekip ruhuyla tek
yumruk, tek vücut olup profesyonel
çözümleri sunmaktır.

Team management is to be one fist,
one body with team spirit and to offer
professional solutions.



AR-GE / R&D

Araştırmak, araştırmak ve yine araştı-
rmak...Müşterinin işini en uygun mali-
yetle en pratik ve ergonomik şekilde
teknoloji ile çözmek için araştırmak...

To investigate, to investigate and to
investigate again... Researching to
solve the customer's business with
technology in the most practical and
ergonomic way at the most affordable
cost...

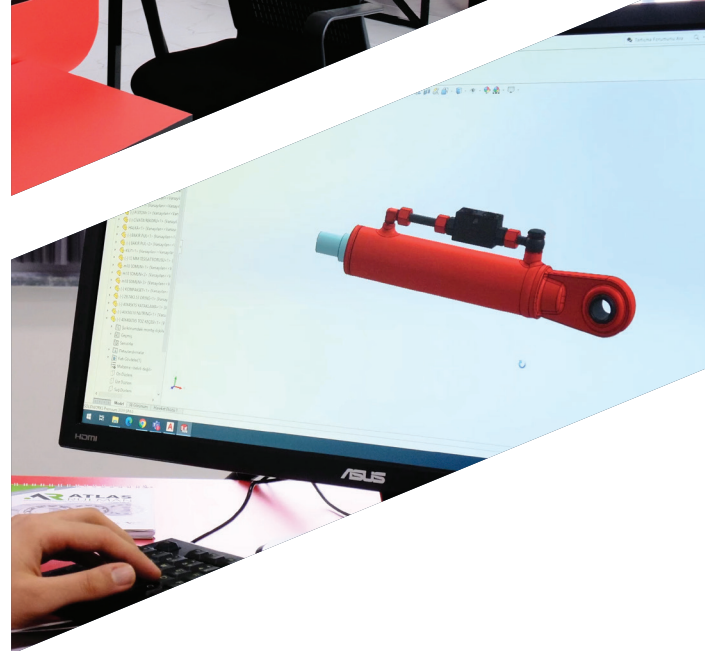

Bizi başarıya ulaştıran 2 Temel



Alanında uzman **Ekibimiz**



ve Güncel **Teknolojimiz**



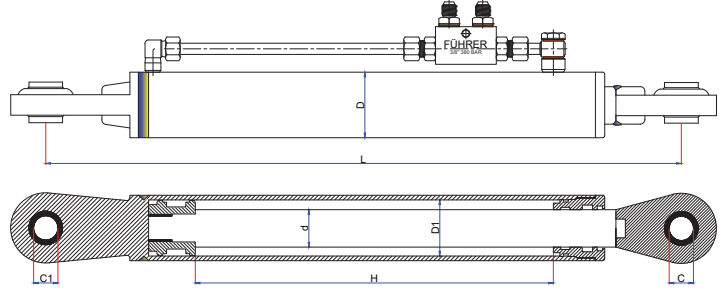
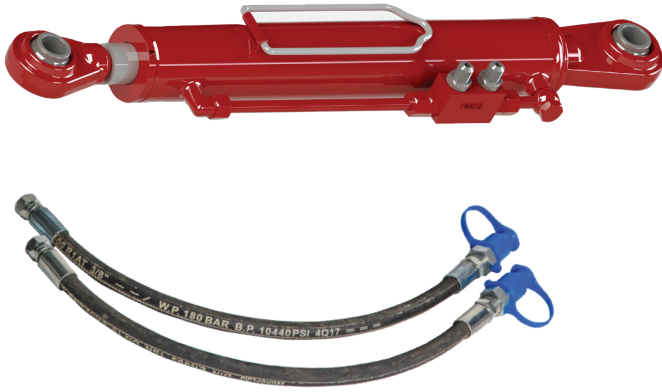

TEKNİK ÖZELLİKLER

Stok Kodu	Ürün Cinsi	Kapasite (Ton)	Kapalı Merkez L - (cm)	Strok H-(mm)	Pim Çapı C1-C (mm)	Tip	Dış Çapı D1-D (mm)	Mil Çapı d - (mm)
FHR-600	ORTAKOL LİFTİ	2	50	195	26*26-GG		60*70	40
FHR-601	ORTAKOL LİFTİ	2	55	245	26*26-GG		60*70	40
FHR-602	ORTAKOL LİFTİ	2	60	295	26*26-GG		60*70	40
FHR-603	ORTAKOL LİFTİ	2	68	365	26*26-GG		60*70	40
FHR-604	ORTAKOL LİFTİ	2	50	195	19*26-DG		60*70	40
FHR-605	ORTAKOL LİFTİ	2	55	245	19*26-DG		60*70	40
FHR-606	ORTAKOL LİFTİ	2	60	295	19*26-DG		60*70	40
FHR-607	ORTAKOL LİFTİ	2	68	365	19*26-DG		60*70	40
FHR-608	ORTAKOL LİFTİ	2	50	195	26*26-GG	DİK	60*70	40
FHR-609	ORTAKOL LİFTİ	2	55	245	26*26-GG	DİK	60*70	40
FHR-610	ORTAKOL LİFTİ	2	60	295	26*26-GG	DİK	60*70	40
FHR-611	ORTAKOL LİFTİ	2	68	365	26*26-GG	DİK	60*70	40
FHR-612	ORTAKOL LİFTİ	2	50	195	19*26-DG	DİK	60*70	40
FHR-613	ORTAKOL LİFTİ	2	55	245	19*26-DG	DİK	60*70	40
FHR-614	ORTAKOL LİFTİ	2	60	295	19*26-DG	DİK	60*70	40
FHR-615	ORTAKOL LİFTİ	2	68	365	19*26-DG	DİK	60*70	40
FHR-616	ORTAKOL LİFTİ	3	50	195	26*26-GG		63*75	40
FHR-617	ORTAKOL LİFTİ	3	55	245	26*26-GG		63*75	40
FHR-618	ORTAKOL LİFTİ	3	60	295	26*26-GG		63*75	40
FHR-619	ORTAKOL LİFTİ	3	68	365	19*26-DG		63*75	40
FHR-620	ORTAKOL LİFTİ	3	50	195	19*26-DG		63*75	40
FHR-621	ORTAKOL LİFTİ	3	55	245	19*26-DG		63*75	40
FHR-622	ORTAKOL LİFTİ	3	60	295	19*26-DG		63*75	40
FHR-623	ORTAKOL LİFTİ	3	68	365	19*26-DG		63*75	40
FHR-624	ORTAKOL LİFTİ	3	50	195	26*26-GG	DİK	63*75	40
FHR-625	ORTAKOL LİFTİ	3	55	245	26*26-GG	DİK	63*75	40
FHR-626	ORTAKOL LİFTİ	3	60	295	26*26-GG	DİK	63*75	40
FHR-627	ORTAKOL LİFTİ	3	68	365	26*26-GG	DİK	63*75	40
FHR-628	ORTAKOL LİFTİ	3	50	195	19*26-DG	DİK	63*75	40
FHR-629	ORTAKOL LİFTİ	3	55	245	19*26-DG	DİK	63*75	40
FHR-630	ORTAKOL LİFTİ	3	60	295	19*26-DG	DİK	63*75	40
FHR-631	ORTAKOL LİFTİ	3	68	365	19*26-DG	DİK	63*75	40

TRAKTÖR ORTAKOL LİFTLERİ

FHR-700

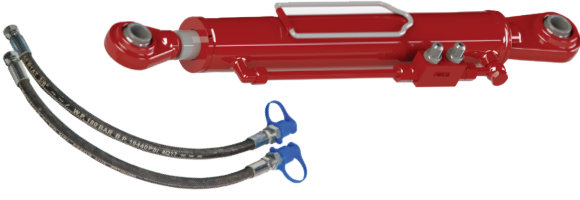

TEKNİK ÖZELLİKLER

Stok Kodu	Ürün Cinsi	Kapasite (Ton)	Kapalı Merkez L - (cm)	Strok H-(mm)	Pim Çapı C1-C (mm)	Tip	Dış Çapı D1-D (mm)	Mil Çapı d - (mm)
FHR-700	ORTAKOL LİFTİ	5	50	165	26*26-GG		70*80	45
FHR-701	ORTAKOL LİFTİ	5	55	215	26*26-GG		70*80	45
FHR-702	ORTAKOL LİFTİ	5	60	265	26*26-GG		70*80	45
FHR-703	ORTAKOL LİFTİ	5	68	345	26*26-GG		70*80	45
FHR-704	ORTAKOL LİFTİ	5	50	165	19*26-DG		70*80	45
FHR-705	ORTAKOL LİFTİ	5	55	215	19*26-DG		70*80	45
FHR-706	ORTAKOL LİFTİ	5	60	265	19*26-DG		70*80	45
FHR-707	ORTAKOL LİFTİ	5	68	345	19*26-DG		70*80	45
FHR-708	ORTAKOL LİFTİ	5	50	170	26*26-GG	DİK	70*80	45
FHR-709	ORTAKOL LİFTİ	5	55	215	26*26-GG	DİK	70*80	45
FHR-710	ORTAKOL LİFTİ	5	60	265	26*26-GG	DİK	70*80	45
FHR-711	ORTAKOL LİFTİ	5	68	345	26*26-GG	DİK	70*80	45
FHR-712	ORTAKOL LİFTİ	5	50	165	19*26-DG	DİK	70*80	45
FHR-713	ORTAKOL LİFTİ	5	55	215	19*26-DG	DİK	70*80	45
FHR-714	ORTAKOL LİFTİ	5	60	265	19*26-DG	DİK	70*80	45
FHR-715	ORTAKOL LİFTİ	5	68	345	19*26-DG	DİK	70*80	45
FHR-716	ORTAKOL LİFTİ	2	50	145	26*26-GG	C.KAFA	60*70	40
FHR-717	ORTAKOL LİFTİ	2	55	195	26*26-GG	C.KAFA	60*70	40
FHR-718	ORTAKOL LİFTİ	2	60	245	26*26-GG	C.KAFA	60*70	40
FHR-719	ORTAKOL LİFTİ	2	68	325	26*26-GG	C.KAFA	60*70	40
FHR-720	ORTAKOL LİFTİ	3	50	145	26*26-GG	C.KAFA	63*75	40
FHR-721	ORTAKOL LİFTİ	3	55	195	26*26-GG	C.KAFA	63*75	40
FHR-722	ORTAKOL LİFTİ	3	60	245	26*26-GG	C.KAFA	63*75	40
FHR-723	ORTAKOL LİFTİ	3	68	325	26*26-GG	C.KAFA	63*75	40
FHR-724	ORTAKOL LİFTİ	5	50	125	26*26-GG	C.KAFA	70*80	45
FHR-725	ORTAKOL LİFTİ	5	55	175	26*26-GG	C.KAFA	70*80	45
FHR-726	ORTAKOL LİFTİ	5	60	225	26*26-GG	C.KAFA	70*80	45
FHR-727	ORTAKOL LİFTİ	5	68	305	26*26-GG	C.KAFA	70*80	45
FHR-728	ORTAKOL LİFTİ	7,5 CAT2	50	110	26*26-GG	C.KAFA MAFSALLI	90*105	50
FHR-729	ORTAKOL LİFTİ	7,5 CAT2	55	160	26*26-GG	C.KAFA MAFSALLI	90*105	50
FHR-730	ORTAKOL LİFTİ	7,5 CAT2	60	210	26*26-GG	C.KAFA MAFSALLI	90*105	50
FHR-731	ORTAKOL LİFTİ	7,5 CAT2	68	290	26*26-GG	C.KAFA MAFSALLI	90*105	50
FHR-732	ORTAKOL LİFTİ	7,5 CAT3	50	85	26*26-GG	C.KAFA MAFSALLI	90*105	50
FHR-733	ORTAKOL LİFTİ	7,5 CAT3	55	135	26*26-GG	C.KAFA MAFSALLI	90*105	50
FHR-734	ORTAKOL LİFTİ	7,5 CAT3	60	185	26*26-GG	C.KAFA MAFSALLI	90*105	50
FHR-735	ORTAKOL LİFTİ	7,5 CAT3	68	265	26*26-GG	C.KAFA MAFSALLI	90*105	50

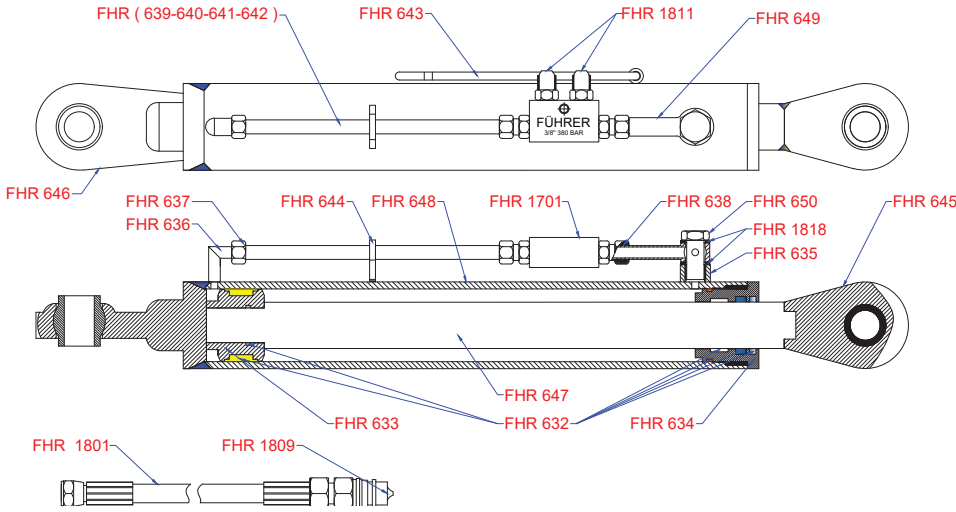

TEKNİK ÖZELLİKLER

Stok Kodu	Ürün Cinsi	Grup	Tip
FHR-632	ORTAKOL LİFTİ TAMİR TAKIMI	HİD. ORTAKOL - HİD.DİK AYARLI KOL	STANDART
FHR-633	ORTAKOL LİFT PİSTONU	HİD. ORTAKOL - HİD.DİK AYARLI KOL	STANDART
FHR-634	ORTAKOL LİFT KEPİ	HİD. ORTAKOL - HİD.DİK AYARLI KOL	STANDART
FHR-635	3/8 KAYNAKLIK MAŞON	HİD. ORTAKOL - HİD.DİK AYARLI KOL	STANDART
FHR-636	M18X1.5 KAYNAKLIK DİRSEK	HİD. ORTAKOL - HİD.DİK AYARLI KOL	STANDART
FHR-637	M18X1.5 SOMUN	HİD. ORTAKOL - HİD.DİK AYARLI KOL	STANDART
FHR-638	12MM YÜSSÜK	HİD. ORTAKOL - HİD.DİK AYARLI KOL	STANDART
FHR-639	12MM TESİSAT BORUSU	HİD. ORTAKOL - HİD.DİK AYARLI KOL	68 CM
FHR-640	12MM TESİSAT BORUSU	HİD. ORTAKOL - HİD.DİK AYARLI KOL	60 CM
FHR-641	12MM TESİSAT BORUSU	HİD. ORTAKOL - HİD.DİK AYARLI KOL	55 CM
FHR-642	12MM TESİSAT BORUSU	HİD. ORTAKOL - HİD.DİK AYARLI KOL	50 CM
FHR-643	ASKI APARATI	HİD. ORTAKOL	STANDART
FHR-644	TESİSAT BORU DESTEĞİ	HİD. ORTAKOL - HİD.DİK AYARLI KOL	STANDART
FHR-645	MİL BAŞLIGI	HİD. ORTAKOL - HİD.DİK AYARLI KOL	STANDART
FHR-646	BORU BAŞLIGI	HİD. ORTAKOL - HİD.DİK AYARLI KOL	STANDART
FHR-647	KROMLU MİL	HİD. ORTAKOL - HİD.DİK AYARLI KOL	STANDART
FHR-648	DIŞ BORU	HİD. ORTAKOL - HİD.DİK AYARLI KOL	STANDART
FHR-649	HALKA REKORU 12X17	HİD. ORTAKOL - HİD.DİK AYARLI KOL	STANDART
FHR-650	CIVATA RAKORU	HİD. ORTAKOL - HİD.DİK AYARLI KOL	STANDART

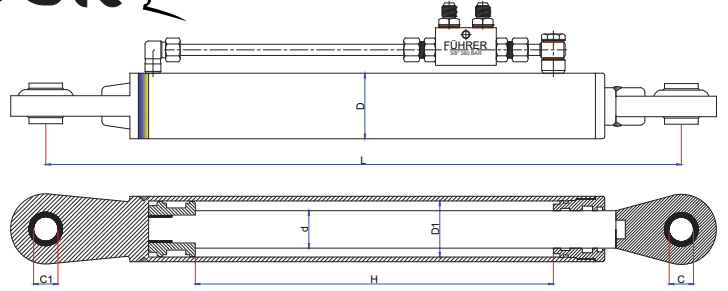

TEKNİK ÖZELLİKLER

Stok Kodu	Ürün Cinsi	Kapasite (Ton)	Kapalı Merkez L - (cm)	Strok H-(mm)	Pim Çapı C1-C (mm)	Tip	Dış Çapı D1-D (mm)	Mil Çapı d - (mm)
FHR-651	ORTAKOL LİFTİ	2	50	195	26*26-GG		50*60	35
FHR-652	ORTAKOL LİFTİ	2	55	245	26*26-GG		50*60	35
FHR-653	ORTAKOL LİFTİ	2	60	295	26*26-GG		50*60	35
FHR-654	ORTAKOL LİFTİ	2	68	365	26*26-GG		50*60	35
FHR-655	ORTAKOL LİFTİ	2	50	195	19*26-DG		50*60	35
FHR-656	ORTAKOL LİFTİ	2	55	245	19*26-DG		50*60	35
FHR-657	ORTAKOL LİFTİ	2	60	295	19*26-DG		50*60	35
FHR-658	ORTAKOL LİFTİ	2	68	365	19*26-DG		50*60	35
FHR-659	ORTAKOL LİFTİ	2	50	195	26*26-GG	DİK	50*60	35
FHR-660	ORTAKOL LİFTİ	2	55	245	26*26-GG	DİK	50*60	35
FHR-661	ORTAKOL LİFTİ	2	60	295	26*26-GG	DİK	50*60	35
FHR-662	ORTAKOL LİFTİ	2	68	365	26*26-GG	DİK	50*60	35
FHR-663	ORTAKOL LİFTİ	2	50	195	19*26-DG	DİK	50*60	35
FHR-664	ORTAKOL LİFTİ	2	55	245	19*26-DG	DİK	50*60	35
FHR-665	ORTAKOL LİFTİ	2	60	295	19*26-DG	DİK	50*60	35
FHR-666	ORTAKOL LİFTİ	2	68	365	19*26-DG	DİK	50*60	35
FHR-667	ORTAKOL LİFTİ	3	50	195	26*26-GG		60*70	40
FHR-668	ORTAKOL LİFTİ	3	55	245	26*26-GG		60*70	40
FHR-669	ORTAKOL LİFTİ	3	60	295	26*26-GG		60*70	40
FHR-670	ORTAKOL LİFTİ	3	68	365	26*26-GG		60*70	40
FHR-671	ORTAKOL LİFTİ	3	50	195	19*26-DG		60*70	40
FHR-672	ORTAKOL LİFTİ	3	55	245	19*26-DG		60*70	40
FHR-673	ORTAKOL LİFTİ	3	60	295	19*26-DG		60*70	40
FHR-674	ORTAKOL LİFTİ	3	68	365	19*26-DG		60*70	40
FHR-675	ORTAKOL LİFTİ	3	50	195	26*26-GG	DİK	60*70	40
FHR-676	ORTAKOL LİFTİ	3	55	245	26*26-GG	DİK	60*70	40
FHR-677	ORTAKOL LİFTİ	3	60	295	26*26-GG	DİK	60*70	40
FHR-678	ORTAKOL LİFTİ	3	68	365	26*26-GG	DİK	60*70	40
FHR-679	ORTAKOL LİFTİ	3	50	195	19*26-DG	DİK	60*70	40
FHR-680	ORTAKOL LİFTİ	3	55	245	19*26-DG	DİK	60*70	40
FHR-681	ORTAKOL LİFTİ	3	60	295	19*26-DG	DİK	60*70	40
FHR-682	ORTAKOL LİFTİ	3	68	365	19*26-DG	DİK	60*70	40



**ÜRÜNLERİMİZLE EN YÜKSEK
VERİMİ ALMANIZ İÇİN ÇALIŞIYORUZ**

**WE WORK TO GET THE HIGHEST EFFICIENCY
WITH OUR PRODUCTS**

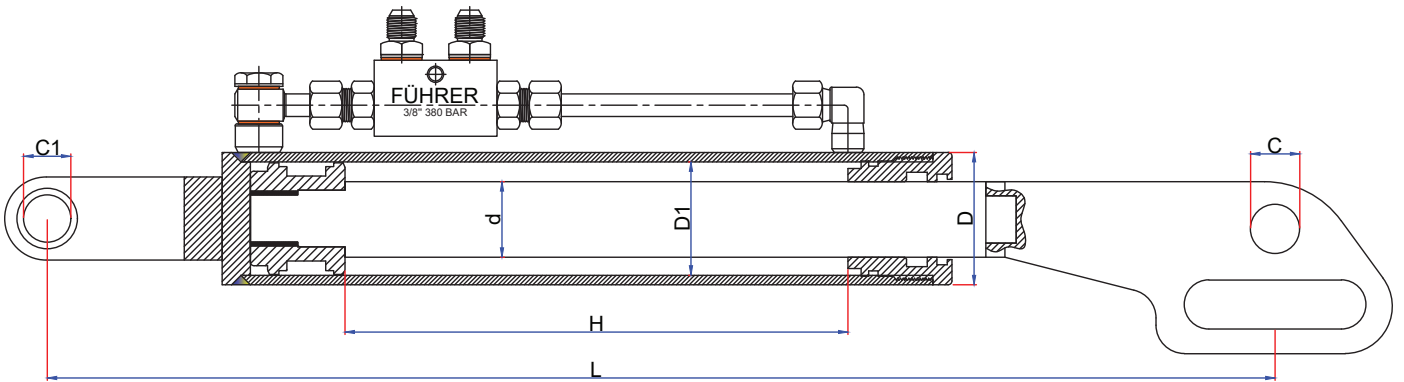
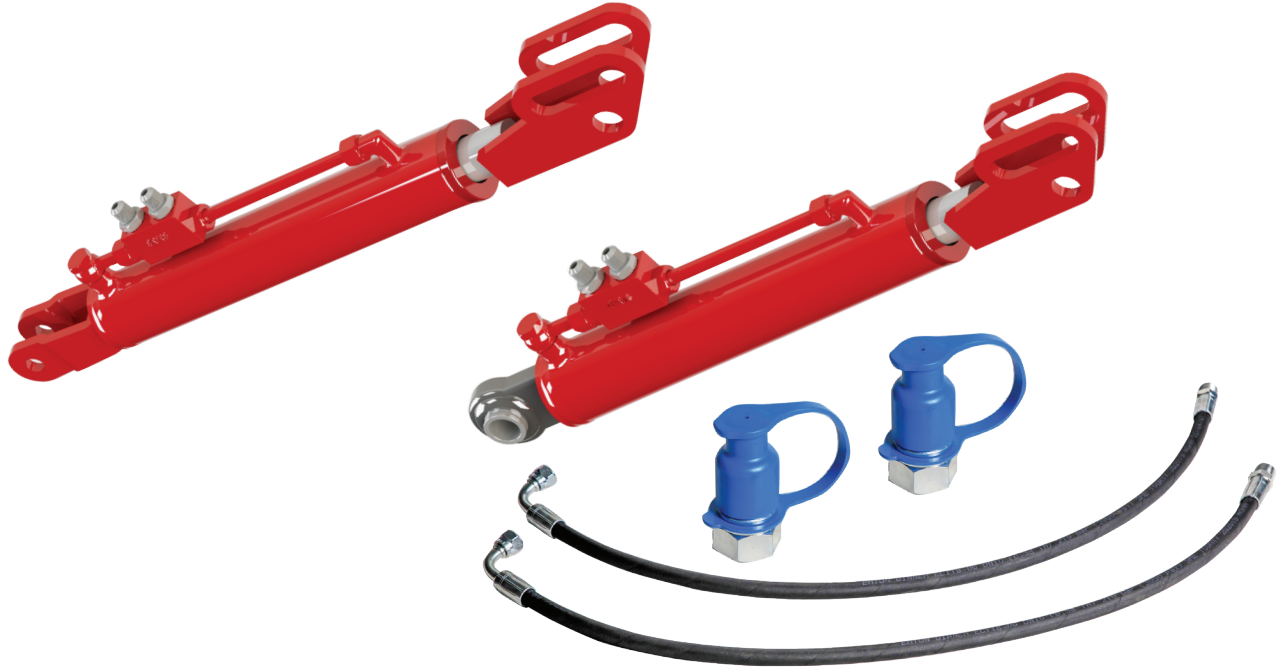

TEKNİK ÖZELLİKLER

Stok Kodu	Ürün Cinsi	Kapasite (Ton)	Kapalı Merkez L-(cm)	Strok H-(mm)	Pim Çapı C1-C-(mm)	Boru Çapı D1-D-(mm)	Mil Çapı d-(mm)
FHR-800	DİK AYARLI KOL LİFTİ	2	45	65	19*26	60*70	40
FHR-801	DİK AYARLI KOL LİFTİ	2	50	115	19*26	60*70	40
FHR-802	DİK AYARLI KOL LİFTİ	2	55	165	19*26	60*70	40
FHR-803	DİK AYARLI KOL LİFTİ	2	60	215	19*26	60*70	40
FHR-804	DİK AYARLI KOL LİFTİ	2	65	265	19*26	60*70	40
FHR-805	DİK AYARLI KOL LİFTİ	2	70	315	19*26	60*70	40
FHR-806	DİK AYARLI KOL LİFTİ	2	45	65	23*26	60*70	40
FHR-807	DİK AYARLI KOL LİFTİ	2	50	115	23*26	60*70	40
FHR-808	DİK AYARLI KOL LİFTİ	2	55	165	23*26	60*70	40
FHR-809	DİK AYARLI KOL LİFTİ	2	60	215	23*26	60*70	40
FHR-810	DİK AYARLI KOL LİFTİ	2	65	265	23*26	60*70	40
FHR-811	DİK AYARLI KOL LİFTİ	2	70	315	23*26	60*70	40

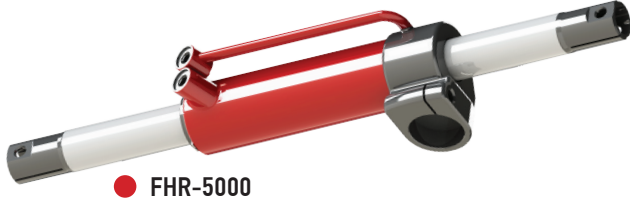

● FHR-5000



● FHR-5001



● FHR-5002

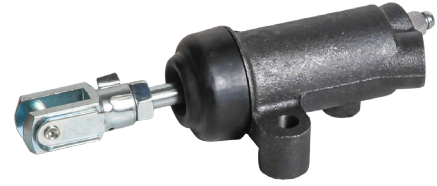

● FHR-5003

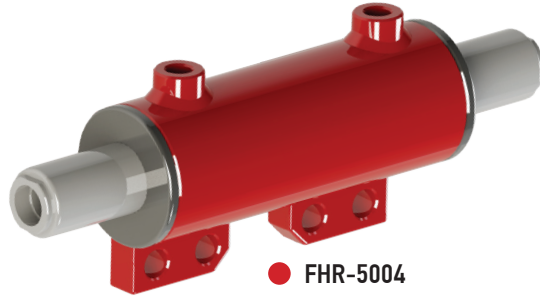

● FHR-5004

TEKNİK ÖZELLİKLER

Stok Kodu	Ürün Cinsi	Oem Kodu	Marka	Model
FHR-5000	HİDROLİK DİREKSİYON SİLİNDİRİ	3773713M91 3763762M91 6202491M91	MASSEY FERGUSON	375, 383, 390T, 393, 398, 399
FHR-5001	HİDROLİK DİREKSİYON SİLİNDİRİ	-	MASSEY FERGUSON	-
FHR-5002	T FREN MERKEZİ (KALIN DELİK)	84247064	FİAT	TD65D- TD75D
FHR-5003	T FREN MERKEZİ (İNCE DELİK)	87748455	FİAT	TD5.110- TD5.90
FHR-5004	HİDROLİK DİREKSİYON SİLİNDİRİ	0013901U91	MASSEY FERGUSON	240- 260

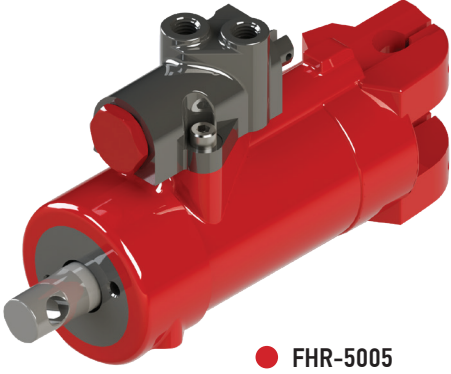

● FHR-5005

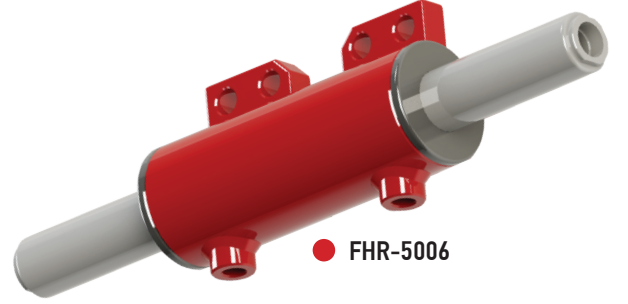

● FHR-5006

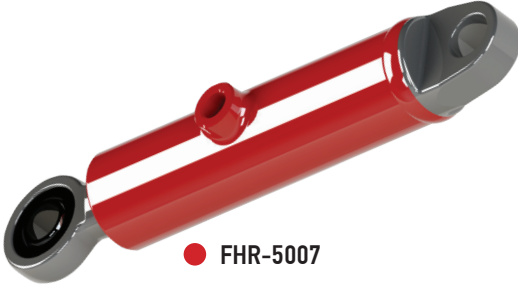

● FHR-5007

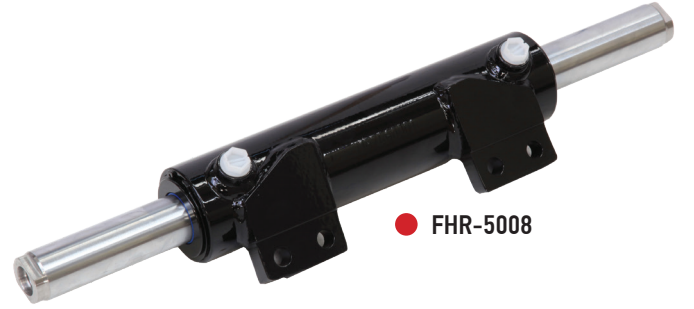

● FHR-5008



● FHR-5009

TEKNİK ÖZELLİKLER

Stok Kodu	Ürün Cinsi	Oem Kodu	Marka	Model
FHR-5005	ÖN DİREKSİYON SİLİNDİRİ	1853466M93, 1884374M93,3186323M91, 3773740M91,1830316M91, 1853195M92, 1853466M91, 1884374M91, 1885579M91,3186320M91, 3186320M92, 505525M91	MASSEY FERGUSON	165, 168, 175, 175S, 178 185, 188, 265, 275, 285, 290 375, 390
FHR-5006	HİD.DİREKSİYON SİLİNDİR MİLİ 10 CM UZUN	0013901U91	MASSEY FERGUSON	240-260
FHR-5007	DESTEK SİLİNDİRİ (HORTUM-RAKOR-PİM)	84520524	CASE IH	65C- 75C
FHR-5008	HİDROLİK DİREKSİYON SİLİNDİRİ	7182640001	BAŞAK	-
FHR-5009	HİDROLİK ORTAKOL	-	BAŞAK	-

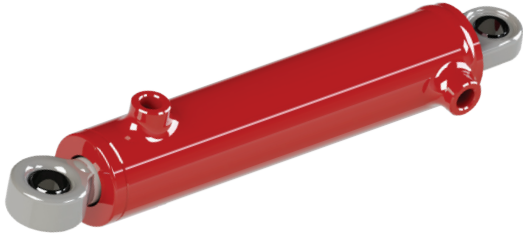

● FHR-5010

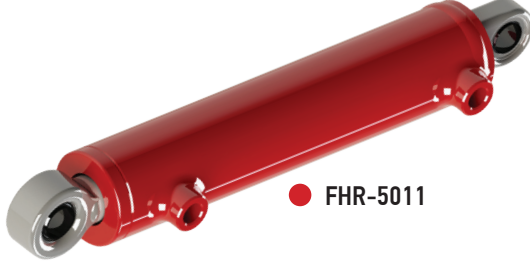

● FHR-5011

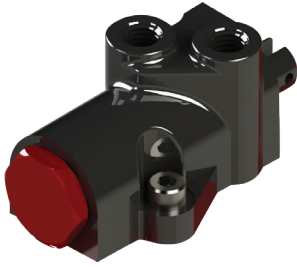

● FHR-5013



● FHR-5012 - PARALEL



● FHR-5012 - ÇAPRAZ



● FHR-5014

TEKNİK ÖZELLİKLER

Stok Kodu	Ürün Cinsi	Oem Kodu	Marka	Model
FHR-5010	HİDROLİK DİREKSİYON SİLİNDİRİ	5088311	FİAT	54C-TT
FHR-5011	HİDROLİK DİREKSİYON SİLİNDİRİ	5083321	FİAT	80-66DT
FHR-5012	HİDROLİK DİREKSİYON SİLİNDİRİ (ROTLU) ÇAPRAZ RAKORLU - PARALEL RAKORLU	5093753, 5173145, 5113130, 67639, 5098112 - 5113093 - 5123968 - 5125260 - 5123022-5143022- 5189897 - 5140638	FİAT	6056 - 7056 - 45 - 66 - 80 - 66 - 100 - 110 - 55 - 65 - 446 - 466 - 566 - 666 - 766 - 580 - 680 - 780 - 880 - 880/5 - 980 - 55/46 - 55/66 - 60/66 - 65/46 - 65/66 - 70/66 - 80/66 - 55/90 - 60/90 - 65/90 - 70/90 - 80/90 - 85/90 - 90/90 - 100/90 - 110/90 - 60/93 - 60/94 - 6293 - 62/94 - 72/93 - 72/94 - 82/93 - 82/94
FHR-5013	ÖN DİREKSİYON BEYİNCİĞİ	11407	MASSEY FERGUSON	165 - 185 - 275- 285 - 290
FHR-5014	ÖN DİREKSİYON SİLİNDİRİ BEYİNSİZ	532193M91 - 1605121M92 - 3773711M91	MASSEY FERGUSON	"255- 265- 270-275- 285-290"

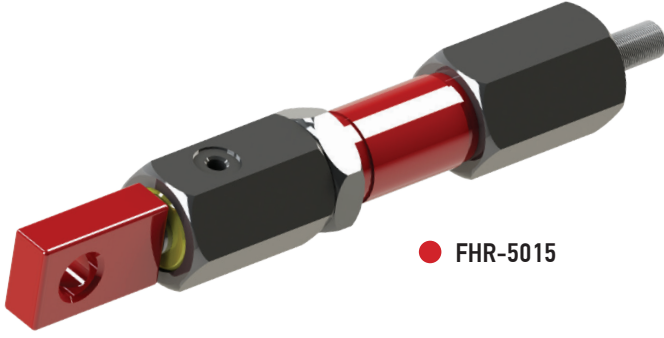

● FHR-5015

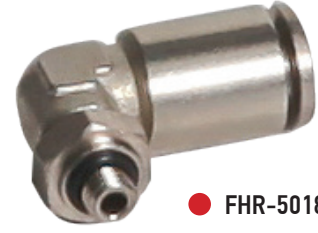

● FHR-5018

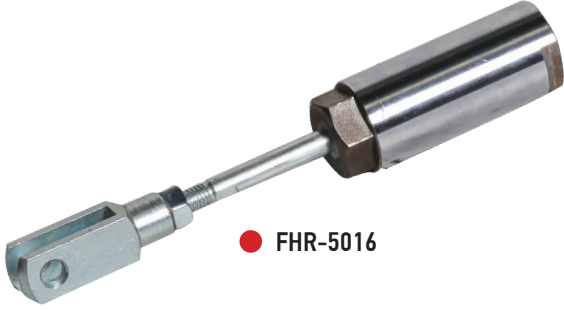

● FHR-5016



● FHR-5019



● FHR-5017

TEKNİK ÖZELLİKLER

Stok Kodu	Ürün Cinsi	Oem Kodu	Marka	Model
FHR-5015	AUTO LİFT SİLİNDİRİ	0016658U91	MASSEY FERGUSON	-
FHR-5016	AUTO SİLİNDİR DIŞ ÇATAL MEKANİZMASI	0017100U91	MASSEY FERGUSON	277-3050-3105
FHR-5017	AUTO SİLİNDİR MEKANİZMASI (HORTUMU)	17096	MASSEY FERGUSON	-
FHR-5018	AUTO SİLİNDİR MEKANİZMASI (ÇELİK DİRSEK)	17097	MASSEY FERGUSON	-
FHR-5019	AUTO SİLİNDİR MEKANİZMASI (DÜZ RAKOR)	17098	MASSEY FERGUSON	-

● FHR-5020



● FHR-5021



● FHR-5022



● FHR-5023



● FHR-5024

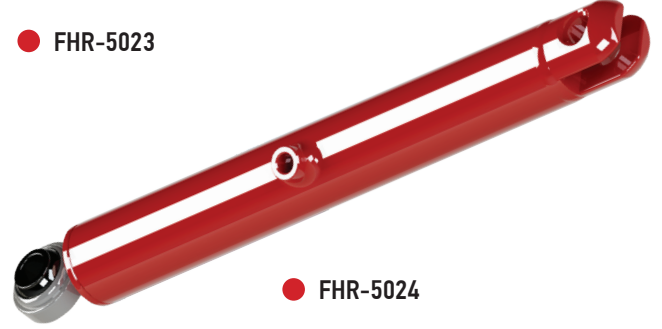

TEKNİK ÖZELLİKLER

Stok Kodu	Ürün Cinsi	Oem Kodu	Marka	Model
FHR-5020	HİDROLİK DİREKSİYON AMORTİSÖRÜ (SAĞ-SOL)	3401553M92-3774728V91-3774728M91-3773716M91-3443036M91	MASSEY FERGUSON	231, 240, 240EF.-255 EP-260 250, 253, 360, 362, 20D, 30E, 40E
FHR-5021	HİDROLİK DİREKSİYON AMORTİSÖRÜ (SOL)	3401240M91, 0011403U91	MASSEY FERGUSON	20 - 202 - 203 - 205-2135 - 230 - 240 - 240S - 245 - 250 - 255 - 260 - 550 - 560
FHR-5022	HİDROLİK DİREKSİYON AMORTİSÖRÜ (SAĞ)	3401241M91, 0011404U91	MASSEY FERGUSON	20, 202, 203, 205, 2135
FHR-5023	HİDROLİK DİREKSİYON SİLİNDİRİ	3429989M91-00112130U1	MASSEY FERGUSON	265, 275, 285, 290, 365, 375, 390, 396, 398, 399, 4225, 4235, 4240, 4245, 4255, 4260, 4265, 4270, 4325, 4335, 4345, 4355, 4360, 4365, 4370, 5425, 5435, 5445, 5455, 6610, 6120, 5445, 5435, 6130, 6140, 6235, 6245, 6255
FHR-5024	DESTEK SİLİNDİRİ (SAĞ)	1749276M91-3773709M91	MASSEY FERGUSON	200 - 300 - 3000 SERİLERİ

● FHR-5025



● FHR-5028



● FHR-5026



● FHR-5027



● FHR-5029



TEKNİK ÖZELLİKLER

Stok Kodu	Ürün Cinsi	Oem Kodu	Marka	Model
FHR-5025	DESTEK SİLİNDİRİ (SOL)	3773710M91- 1748456M92	MASSEY FERGUSON	200 - 300 - 3000 SERİLERİ
FHR-5026	HİDROLİK DİREKSİYON SİLİNDİRİ	7256522	TÜMOSAN	4X4
FHR-5027	HİDROLİK DİREKSİYON SİLİNDİRİ	7255837	TÜMOSAN	4x2
FHR-5028	"HİDROLİK DİREKSİYON SİLİNDİRİ (ROTLU)"	7253799	TÜMOSAN	74,80N- 82,80N
FHR-5029	HİDROLİK DİREKSİYON SİLİNDİRİ	5189895- 5142046-5173144	FİAT	F100DT, C3394, F110DT, C3394, F110DT, 45-66, D3041, 50-66, D3041, 55- 56DT, 55-66DT, D3104, 60-56DT, D4628, 60-66, D3104, 60-90DT, D3104, 60-93DT, 60-94DT, 65-90DT, D3041-3104, 65-93DT, 65-94DT, 70-66SDT, D4628, 70-90DT, D3104, 80-90DT, D3104, 85-90DT, 90-90DT, D3104, 100-90DT, 110-90DT, TD60D, TD70D, TD75D, TD80D, TD85D, TD90D, TD95D, TD5010, TD5020, TD5030, TD5050, TT60A, TT75A, 5530, 6530

● FHR-5030



● FHR-5031



● FHR-5033



● FHR-5032



● FHR-5034



TEKNİK ÖZELLİKLER

Stok Kodu	Ürün Cinsi	Oem Kodu	Marka	Model
FHR-5030	HİDROLİK DİREKSİYON LİFTİ	716264001	BAŞAK	-
FHR-5031	HİDROLİK DİREKSİYON SİLİNDİRİ (ÇAPRAZ)	5142046 -5156717 -84191439- 84191439 - 5142052 - 5142054 - 5143971 - 5156717	FİAT	980DT, 4566DT, 5546DT, 7056DT, 8066DT, 110.90, DT-115.90, DT-130.90, DT-140.90,DT-100-90, 55-90, 60-90, 65-90, 70-90, 80-90, 85-90, 90-90
FHR-5032	DESTEK SİLİNDİRİ	47839306	FİAT	TT4.55
FHR-5033	DESTEK SİLİNDİRİ	5200740097	BAŞAK	-
FHR-5034	HİDROLİK DİREKSİYON SİLİNDİRİ	188842A1	CASE IH	238-248-258-268- 288-3210-3220-3230- 385- 395-395 XL-4210- 4220-4230-4240-454- 474- 475-484-485-485 XL-495-495 XL-574- 584-585- 585 XL-595-595 XL-674-684-685-685 XL-695-695 XL-784-785-785 XL-795-884-885-885 XL-895-895 XL-995 XL-CX100- CX50-CX60-CX70- CX80-CX90-Hydro 84-Hydro 85-MX100 C-MX80 C-MX90 C



● FHR-5038



● FHR-5035



● FHR-5039

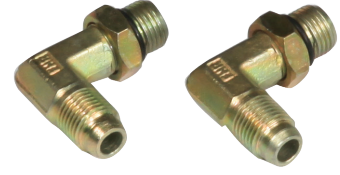

● FHR-5036



● FHR-5037

TEKNİK ÖZELLİKLER

Stok Kodu	Ürün Cinsi	Oem Kodu	Marka	Model
FHR-5035	DESTEK SİLİNDİRİ	E080017331251	ERKUNT	ZF
FHR-5036	GÜÇ DİREKSİYON POMPASI DİRSEK	357197X1	MASSEY FERGUSON	165-168- 175-178-185- 188-265- 275-285-290
FHR-5037	FREN ANA PİSTONU	87748269	FİAT	JX80 TIERII/JXU 105/ JXU 95/JXU 85/JX95 TIERII/JX90 TIERII/ JX55/JX75/JX70 TIERII/JX90_C_4/ JX90_C_2/JX60 TIERII/ JX60/JX70/JX80/ JX55E/JX60E/JX75 TIER 3/JX100 TIER 3/ JX75E/JX90 TIER 3/ JX80E/JX80 TIER 3/ JX70 TIER 3
FHR-5038	DİREKSİYON SİLİNDİRİ	3483329M92	MASSEY FERGUSON	340-350-355-360- 362-365-375-390- 390T
FHR-5039	DİREKSİYON SİLİNDİRİ	3765190M91	MASSEY FERGUSON	2205-2210- 2225-2235

● FHR-5040



● FHR-5042



● FHR-5043



● FHR-5041



● FHR-5044



TEKNİK ÖZELLİKLER

Stok Kodu	Ürün Cinsi	Oem Kodu	Marka	Model
FHR-5040	HİDROLİK DİREKSİYON SİLİNDİRİ	5198883	FİAT	T7030, T7040, T7050, T7060, T7070, T7.220, T7.230, T7.235, T7.245, T7.250, T7.260, T7.270, T8.275, T8.300, T8.320, T8.350, T8.410, T8.435, TM120, TM130, TM140, TM155, TM175, TM190
FHR-5041	HİDROLİK DİREKSİYON SİLİNDİRİ	5144126- 5134221-5144124- 5143970- 5156718	FİAT	F120DT, F130DT, C3394, 70-66DT, D3104, 70-66SDT, 70-88DT, 80-66, D3104, 80-66DT, D3104, 80-88DT, 115-90DT, D3063, 130-90DT, D3063, 140-90DT, 160-90DT, 180-90DT, 90, Farmall 95, JX75, JX80, JX85, JX90, JX95----TD75D, TD80D, TD90D, TD95D, TD5030, TD5050, 5530, 6530
FHR-5042	HİDROLİK DİREKSİYON SİLİNDİRİ	126638-120226	BAŞAK	-
FHR-5043	HİDROLİK DİREKSİYON SİLİNDİRİ	5189995	FİAT	T4040F, T4.100F, T4050F, T4.105F, T4060F, T4.110F, T4.75F, T4.80F, T4.85F, T4.90F, TN65F, TN70F, T4.95F, TN75F, TN80F, TN90F, TN95F, TN75FA, TN85FA, TN95FA, T4030F
FHR-5044	HİDROLİK DESTEK SİLİNDİRİ	-	TÜMOSAN	7000-8000

● FHR-5045



● FHR-5046



● FHR-5048



● FHR-5047

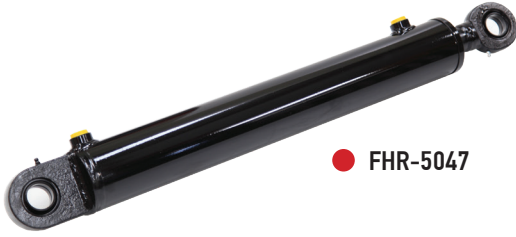

● FHR-5049



TEKNİK ÖZELLİKLER

Stok Kodu	Ürün Cinsi	Oem Kodu	Marka	Model
FHR-5045	HİDROLİK SİLİNDİR GERGİ - HORTUM TAKIMI	-	MASSEY FERGUSON	265-285-2666- 277G-288G-286G- 398-3075- 3085-3095-3105
FHR-5046	HİDROLİK DİREKSİYON SİLİNDİRİ	5189887 - 5165140 - 5190908 - 5083394	FİAT	JX70U, MXM120, MXM130, MXM140, MXU100, MXU110, MXU115, MXU125, MXU130, MXU135
FHR-5047	HİDROLİK DİREKSİYON SİLİNDİRİ	5164023	FİAT	F100DT, D3394, F115DT, 72-93DT, 72-94DT, 82-93DT, 82-94DT, 88-93DT, 88-94DT T5030- 5040-5060-TD80-TD90- TD95-TL70-TL80-TL90- TL100-L75-L85-L95
FHR-5048	HİDROLİK DİREKSİYON SİLİNDİRİ	103137	ERKUNT	-
FHR-5049	HİDROLİK DİREKSİYON SİLİNDİRİ	109070	ERKUNT	-



● FHR-5050



● FHR-5051



● FHR-5052



● FHR-5053



● FHR-5054

TEKNİK ÖZELLİKLER

Stok Kodu	Ürün Cinsi	Oem Kodu	Marka	Model
FHR-5050	HİDROLİK DİREKSİYON SİLİNDİR ROTU	-	FIAT	70/56
FHR-5051	HİDROLİK KALD. SİLİNDİRİ (SAĞ)	47474755	CASE IH	JX 100-JX 90-JX 80-JX 70
FHR-5052	HİDROLİK KALD. SİLİNDİRİ (SOL)	47474754	CASE IH	JX 100 - JX 90 - JX 80 - JX 70 - TD95 - TD100 - TD110
FHR-5053	55/46 HİD. PİSTON ROT DÜZ UÇLU	9960076	FIAT	55-46
FHR-5054	54C HİD. PİSTON ROTU E.M. DÜZ	9962673	FIAT	54C



● FHR-5055



● FHR-5056



● FHR-5057

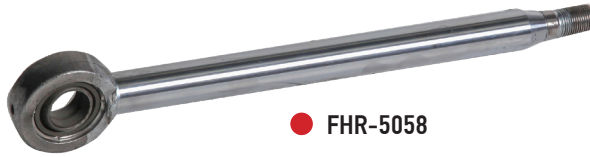

● FHR-5058



● FHR-5063



● FHR-5059



● FHR-5060



● FHR-5061

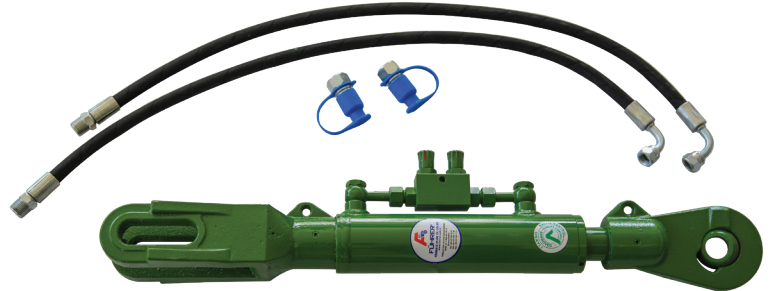

● FHR-5062

TEKNİK ÖZELLİKLER

Stok Kodu	Ürün Cinsi	Oem Kodu	Marka	Model
FHR-5055	REPL. ROTBAŞI	8278057400	TÜMOSAN	-
FHR-5056	REPL PİSTON ROTU	5080087	FIAT	54C
FHR-5057	REPL. PİSTON ROTU	5080092	FIAT	80/66DT
FHR-5058	REPL. PİSTON ROTU	9962188	FIAT	80/66
FHR-5059	PTO KONTROL BEYNİ	47901714	FIAT	TD SERİSİ
FHR-5060	DESTEK PİSTONU	47375572	NEW HOLLAND	
FHR-5061	PTO KONTROL BEYNİ (UZUN KULAK)	51428594-47901713	NEW HOLLAND	TD75D-TD90D- TD100D-TM120- TM150-T4030-T4040
FHR-5062	HİDROLİK DİK AYARLI KOL		JOHNDERE	AL159543 6010 6020 6100 6110 6200 6300 6400 6500
FRH-5063	HİD. DİREKSİYON LİFT MİLİ	1606882M3	MASSEY FERGUSON	



ÖZEL AMAÇLI LİFTLER





A
model

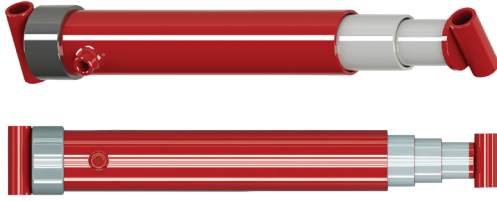

B
model

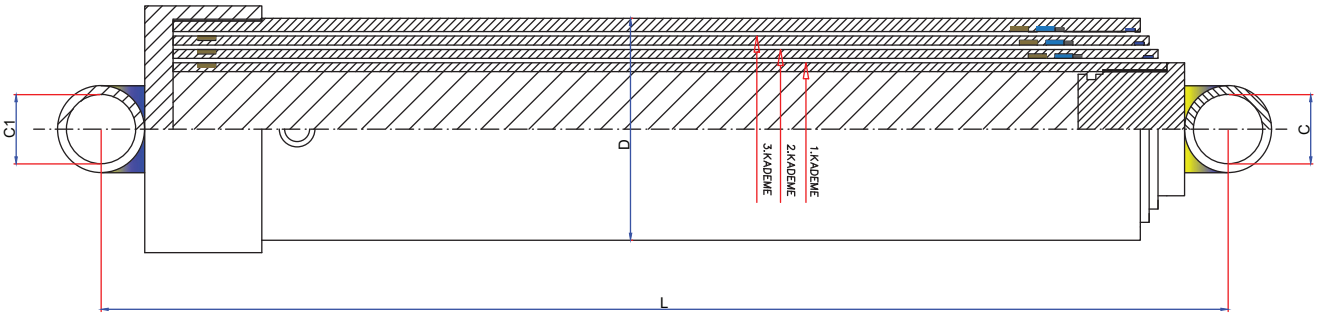

TEKNİK ÖZELLİKLER

Stok Kodu	Kademe	Kapalı Merkez L - (cm)	Kapasite (Ton)	Strok (mm)	Rakor	45 (mm)	60 (mm)	75 (mm)	90 (mm)	105 (mm)	125 (mm)	145 (mm)	170 (mm)
FHR-200	2	43	2	750	5/8	*	*	*					
FHR-201	2	50	2	890	5/8	*	*	*					
FHR-202	2	64	5	920	5/8			*	*	*			
FHR-203	2	74	5	1120	5/8			*	*	*			
FHR-204	2	80	5	1240	5/8			*	*	*			
FHR-205	2	90	5	1440	5/8			*	*	*			
FHR-206	2	100	5	1640	5/8			*	*	*			
FHR-300	3	64	5	1380	5/8		*	*	*	*			
FHR-301	3	74	5	1680	5/8		*	*	*	*			
FHR-302	3	80	5	1860	5/8		*	*	*	*			
FHR-303	3	90	5	2160	5/8		*	*	*	*			
FHR-304	3	100	5	2460	5/8		*	*	*	*			
FHR-305	3	64	10	1380	3/4			*	*	*	*		
FHR-306	3	74	10	1680	3/4			*	*	*	*		
FHR-307	3	80	10	1860	3/4			*	*	*	*		
FHR-308	3	85	10	2010	3/4			*	*	*	*		
FHR-309	3	90	10	2160	3/4			*	*	*	*		
FHR-310	3	100	10	2460	3/4			*	*	*	*		
FHR-311	3	64	15	1380	3/4				*	*	*	*	
FHR-312	3	74	15	1680	3/4				*	*	*	*	
FHR-313	3	80	15	1860	3/4				*	*	*	*	
FHR-314	3	85	15	2010	3/4				*	*	*	*	
FHR-315	3	90	15	2160	3/4				*	*	*	*	
FHR-316	3	100	15	2460	3/4				*	*	*	*	



A
model



B
model

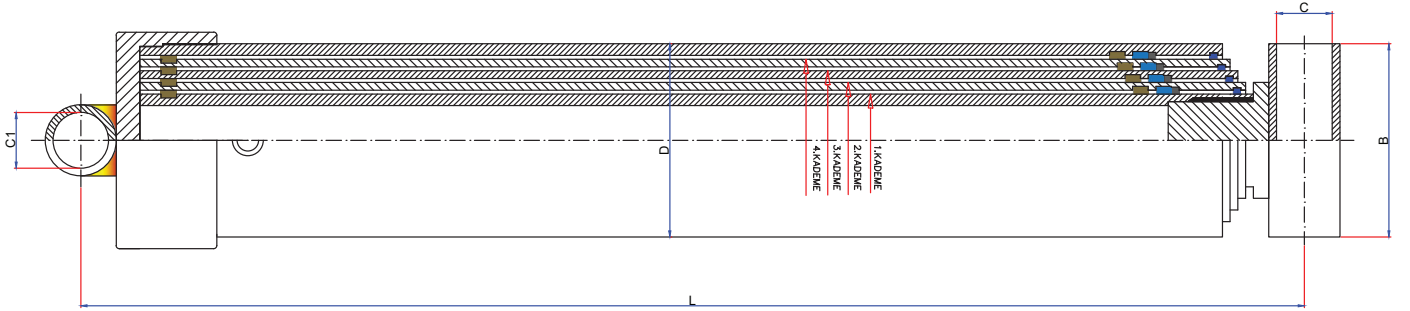

TEKNİK ÖZELLİKLER

Stok Kodu	Kademe	Kapalı Merkez L - (cm)	Kapasite (Ton)	Strok (mm)	Rakor	45 (mm)	60 (mm)	75 (mm)	90 (mm)	105 (mm)	125 (mm)	145 (mm)	170 (mm)
FHR-400	4	64	10	1855	3/4		*	*	*	*	*		
FHR-401	4	74	10	2255	3/4		*	*	*	*	*		
FHR-402	4	80	10	2495	3/4		*	*	*	*	*		
FHR-403	4	85	10	2695	3/4		*	*	*	*	*		
FHR-404	4	90	10	2895	3/4		*	*	*	*	*		
FHR-405	4	100	10	3295	3/4			*	*	*	*	*	
FHR-406	4	64	15	1855	3/4			*	*	*	*	*	
FHR-407	4	74	15	2255	3/4			*	*	*	*	*	
FHR-408	4	80	15	2495	3/4			*	*	*	*	*	
FHR-409	4	85	15	2695	3/4			*	*	*	*	*	
FHR-410	4	90	15	2869	3/4			*	*	*	*	*	
FHR-411	4	100	15	3295	3/4			*	*	*	*	*	
FHR-412	4	64	20	1855	3/4				*	*	*	*	*
FHR-413	4	74	20	2255	3/4				*	*	*	*	*
FHR-414	4	80	20	2495	3/4				*	*	*	*	*
FHR-415	4	85	20	2695	3/4				*	*	*	*	*
FHR-416	4	90	20	2895	3/4				*	*	*	*	*
FHR-417	4	100	20	3295	3/4				*	*	*	*	*



A
model

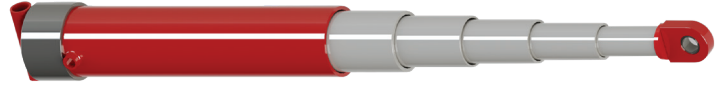

B
model

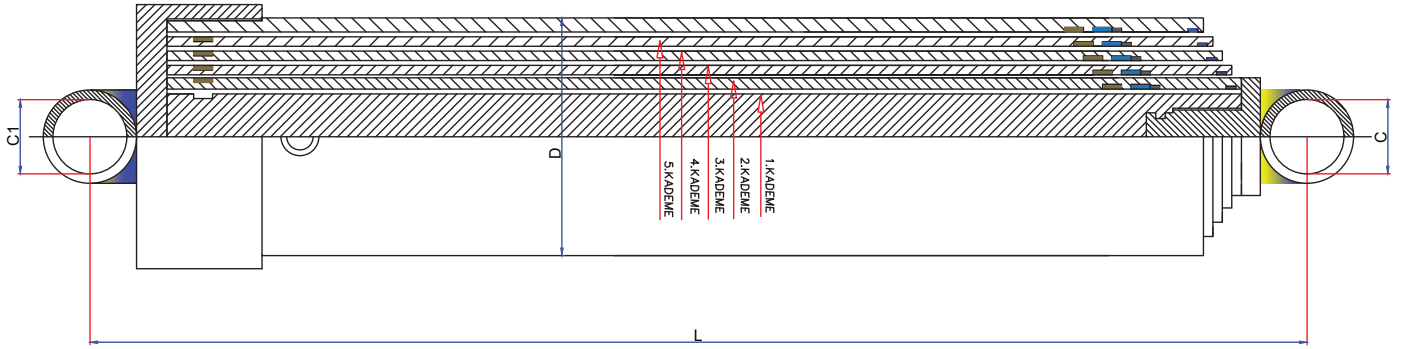

TEKNİK ÖZELLİKLER

Stok Kodu	Kademe	Kapalı Merkez L - (cm)	Kapasite (Ton)	Strok (mm)	Rakor	45 (mm)	60 (mm)	75 (mm)	90 (mm)	105 (mm)	125 (mm)	145 (mm)	170 (mm)
FHR-500	5	64	10	2310	3/4	*	*	*	*	*	*		
FHR-501	5	74	10	2810	3/4	*	*	*	*	*	*		
FHR-502	5	80	10	3110	3/4	*	*	*	*	*	*		
FHR-503	5	85	10	3360	3/4	*	*	*	*	*	*		
FHR-504	5	90	10	3610	3/4	*	*	*	*	*	*		
FHR-505	5	100	10	4110	3/4	*	*	*	*	*	*		
FHR-506	5	64	15	2310	3/4		*	*	*	*	*	*	
FHR-507	5	74	15	2810	3/4		*	*	*	*	*	*	
FHR-508	5	80	15	3110	3/4		*	*	*	*	*	*	
FHR-509	5	85	15	3360	3/4		*	*	*	*	*	*	
FHR-510	5	90	15	3610	3/4		*	*	*	*	*	*	
FHR-511	5	100	15	4110	3/4		*	*	*	*	*	*	
FHR-512	5	64	20	2310	3/4			*	*	*	*	*	*
FHR-513	5	74	20	2810	3/4			*	*	*	*	*	*
FHR-514	5	80	20	3110	3/4			*	*	*	*	*	*
FHR-515	5	85	20	3360	3/4			*	*	*	*	*	*
FHR-516	5	90	20	3610	3/4			*	*	*	*	*	*
FHR-517	5	100	20	4110	3/4			*	*	*	*	*	*

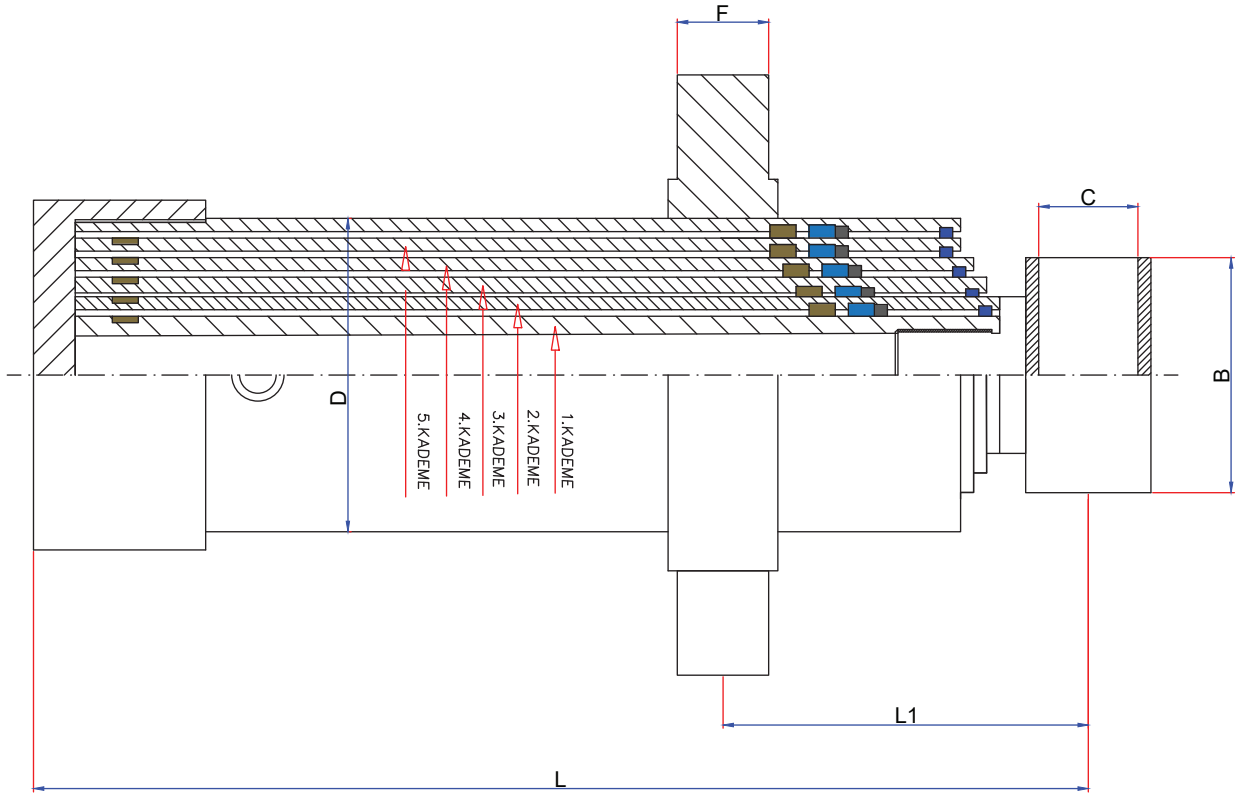
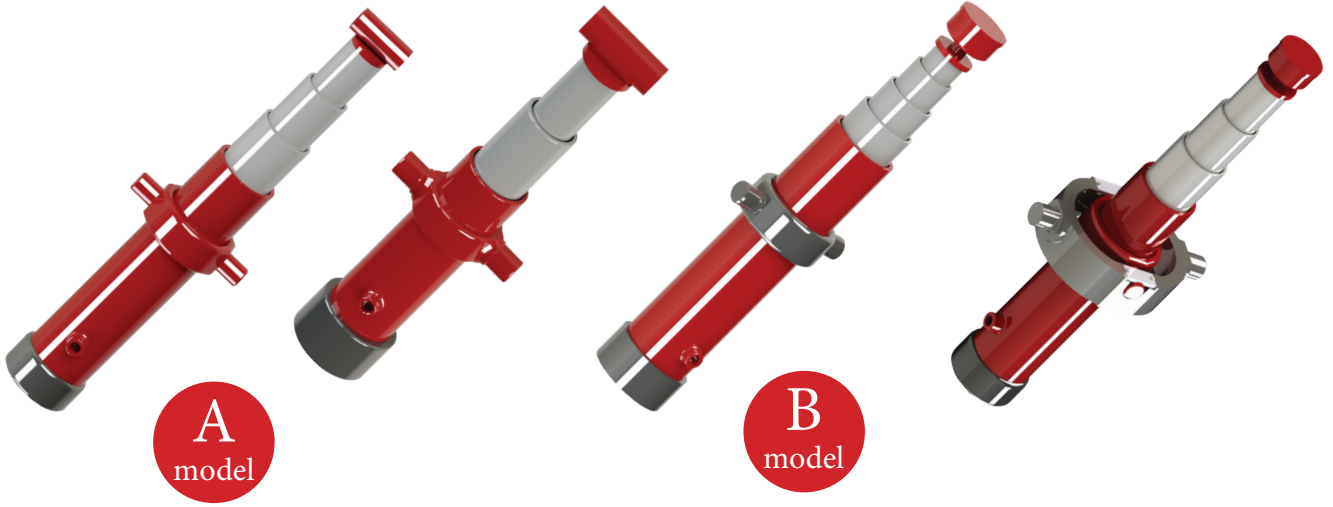

TEKNİK ÖZELLİKLER

Stok Kodu	Kademe	Kapalı Merkez L - (cm)	Kapasite (Ton)	Strok (mm)	Rakor	45 (mm)	60 (mm)	75 (mm)	90 (mm)	105 (mm)	125 (mm)	145 (mm)	170 (mm)
FHR-207	2	38	3	465	5/8		*	*	*				
FHR-208	2	38	5	465	5/8			*	*	*			
FHR-317	3	64	10	1380	3/4			*	*	*	*		
FHR-318	3	64	15	1380	3/4				*	*	*	*	
FHR-418	4	64	10	1855	3/4		*	*	*	*	*		
FHR-419	4	64	15	1855	3/4			*	*	*	*	*	
FHR-518	5	64	10	2310	3/4	*	*	*	*	*	*		
FHR-519	5	64	15	2310	3/4		*	*	*	*	*	*	

TEKNİK ÖZELLİKLER

Stok Kodu	Kademe	Kapalı Merkez L - (cm)	Kapasite (Ton)	Rakor (R)
FHR-7000	2	64	5	5/8
FHR-7001	2	74	5	5/8
FHR-7003	3	64 DAR	5	5/8
FHR-7004	3	74 DAR	5	5/8
FHR-7005	3	64 GENİŞ	10	3/4
FHR-7006	3	80 GENİŞ	10	3/4
FHR-7007	4	64 GENİŞ	10	3/4
FHR-7008	4	80 GENİŞ	10	3/4
FHR-7009	3	64 GENİŞ MAFSALLI	10	3/4
FHR-7010	4	64 GENİŞ MAFSALLI	10	3/4
FHR-7011	2	SAĞ SOL DEVİRMELİ	5	5/8

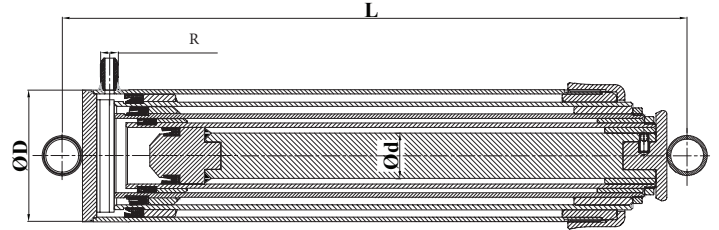

TEKNİK ÖZELLİKLER

Stok Kodu	Ürün Cinsi
FHR-523	TELESKOPIK RÖMORK LİFTİ TAMİR TAKIMI



TEKNİK ÖZELLİKLER

Stok Kodu	Kademe	Kapalı Merkez L - (cm)
FHR-7200	2	KEÇE
FHR-7201	3	KEÇE DAR
FHR-7202	3	KEÇE GENİŞ
FHR-7203	4	KEÇE GENİŞ

TELESKOPIK SİLİNDİR



FHR-520

TELESKOPIK SİLİNDİR

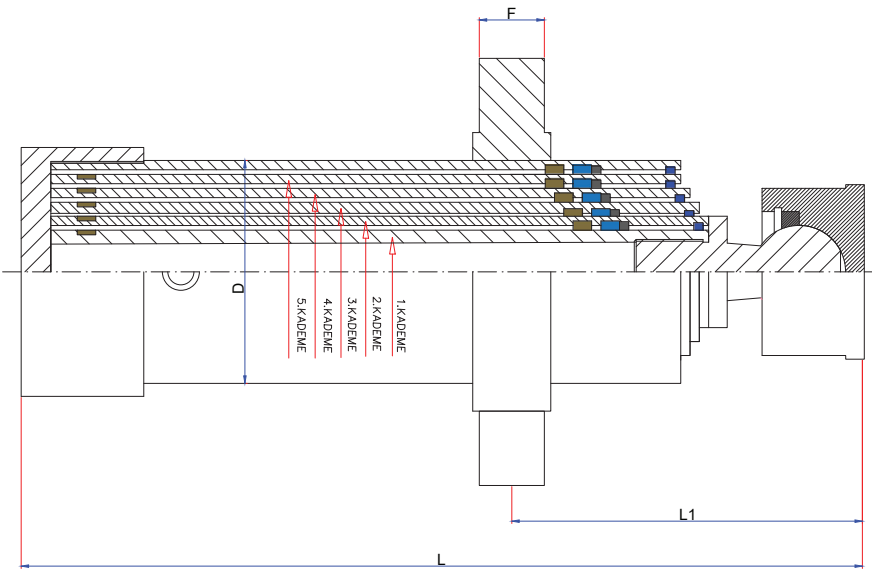
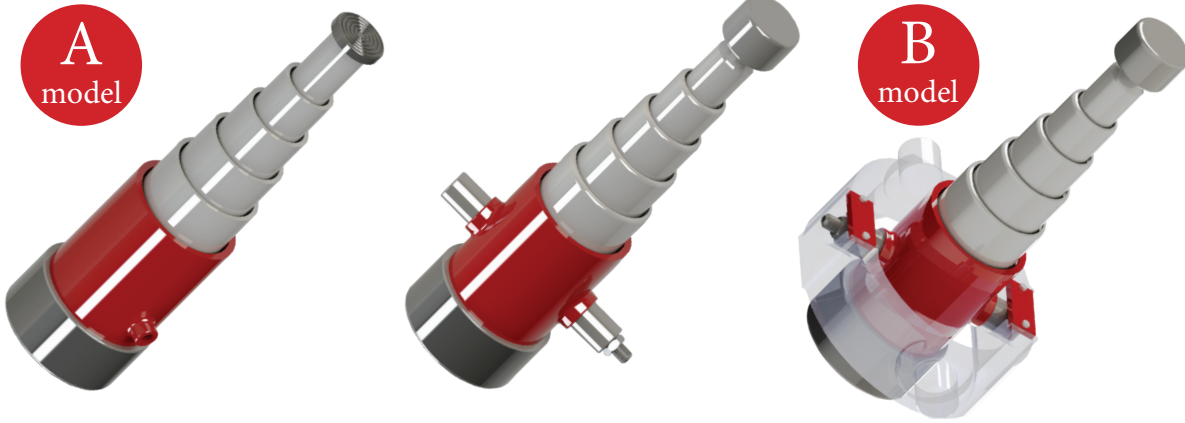

TEKNİK ÖZELLİKLER

Stok Kodu	Ürün Cinsi	Kademe	Kapalı Merkez L - (cm)	Kapasite (Ton)	Strok (mm)	Rakor	45 (mm)	60 (mm)	75 (mm)	90 (mm)	105 (mm)	125 (mm)
FHR-520	3 YANA DEVİRME	5	245	10	450	3/4	*	*	*	*	*	*
FHR-521	KRIKO	5	310	10	450	3/4	*	*	*	*	*	*

FHR-319

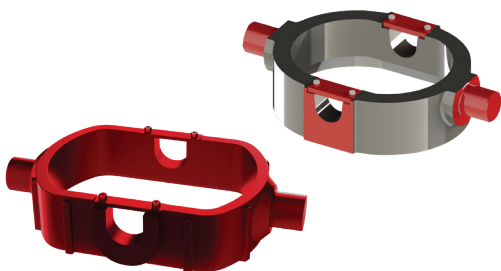

TEKNİK ÖZELLİKLER

Stok Kodu	Ürün Cinsi	Kademe
FHR-319	3 YANA DEVİRME MAFSALI	5
FHR-420	3 YANA DEVİRME MAFSALI	10
FHR-522	3 YANA DEVİRME MAFSALI	15
FHR-832	ORTA KOL MAFSALI	7,5

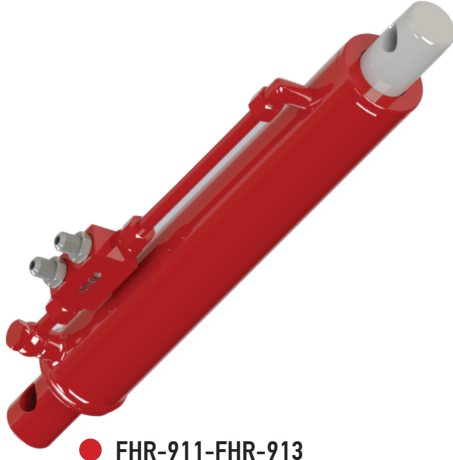

● FHR-911-FHR-913



● FHR-900-FHR-909

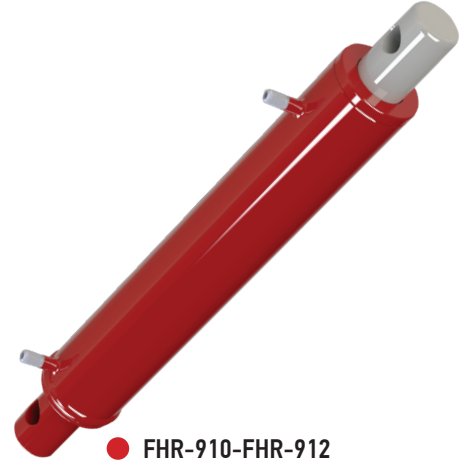

● FHR-910-FHR-912

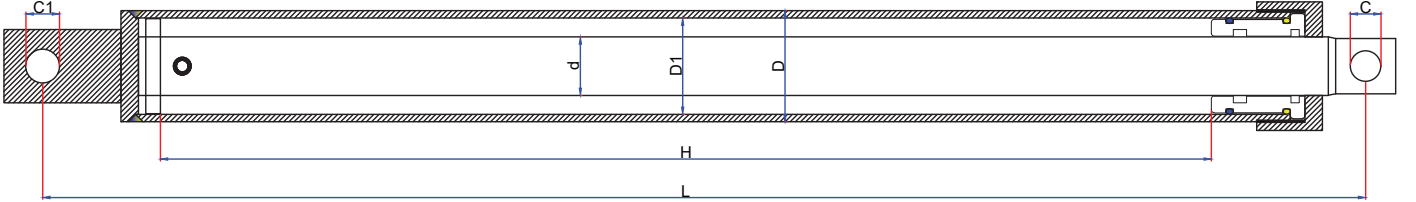

TEKNİK ÖZELLİKLER

Stok Kodu	Ürün Cinsi	Kapasite (Ton)	Kapalı Merkez L - (cm)	Strok H-(mm)	Boru Çapı D1-D (mm)	Mil Çapı d-(mm)
FHR-900	KEPÇE LİFTİ	2	50	350	5*76	40
FHR-901	KEPÇE LİFTİ	2	60	450	5*76	40
FHR-902	KEPÇE LİFTİ	2	68	530	5*76	40
FHR-903	KEPÇE LİFTİ	2	78	630	5*76	40
FHR-904	KEPÇE LİFTİ	2	90	720	5*76	40
FHR-905	KEPÇE LİFTİ	3	68	530	5*90	45
FHR-906	KEPÇE LİFTİ	3	78	630	5*90	45
FHR-907	KEPÇE LİFTİ	3	90	720	5*90	45
FHR-908	KEPÇE LİFTİ	2	78	630	5*76	45
FHR-909	KEPÇE LİFTİ	2	90	720	5*76	45
FHR-910	KOVA LİFTİ	3	53	320	63*75	45
FHR-911	KOVA LİFTİ KİLİTLİ	3	53	320	63*75	45
FHR-912	KOVA LİFTİ	2	53	320	60*70	40
FHR-913	KOVA LİFTİ KİLİTLİ	2	53	320	60*70	40

A
model



B
model

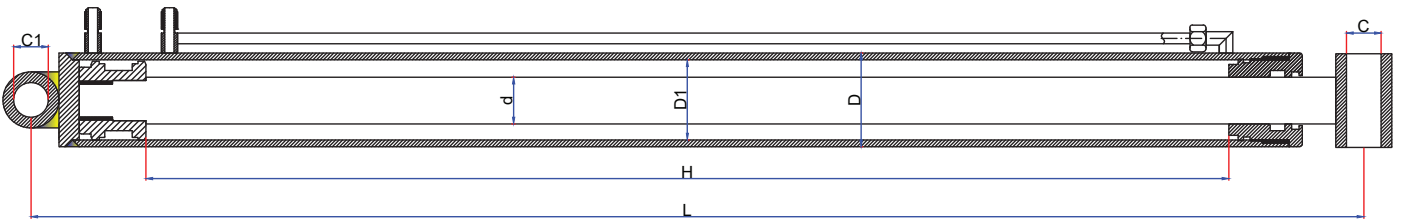
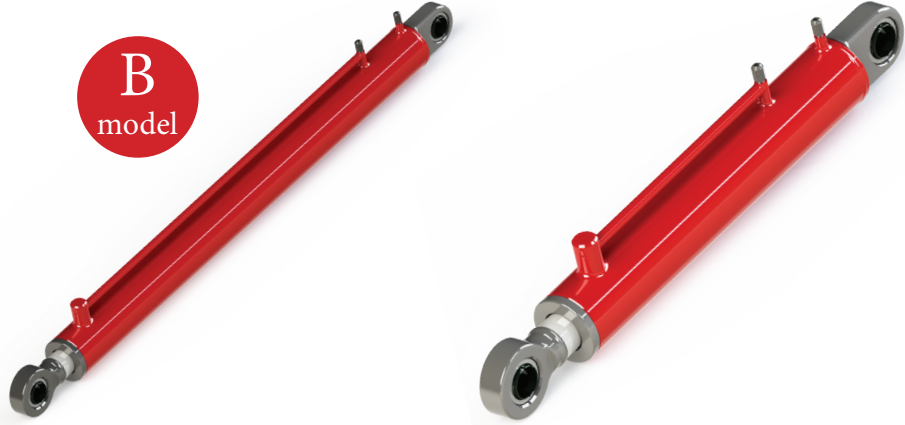

TEKNİK ÖZELLİKLER

Stok Kodu	Ürün Cinsi	Kapasite (Ton)	Kapalı Merkez L - (cm)	Strok H-(mm)	Boru Çapı D1-D (mm)	Mil Çapı d- (mm)
FHR-1000	ÇİFT YÖNLÜ TESİSATLI LİFT	2	40	210	60*70	40
FHR-1001	ÇİFT YÖNLÜ TESİSATLI LİFT	2	50	310	60*70	40
FHR-1002	ÇİFT YÖNLÜ TESİSATLI LİFT	2	60	410	60*70	40
FHR-1003	ÇİFT YÖNLÜ TESİSATLI LİFT	2	70	510	60*70	40
FHR-1004	ÇİFT YÖNLÜ TESİSATLI LİFT	2	80	610	60*70	40
FHR-1005	ÇİFT YÖNLÜ TESİSATLI LİFT	2	90	710	60*70	40
FHR-1006	ÇİFT YÖNLÜ TESİSATLI LİFT	2	100	810	60*70	40

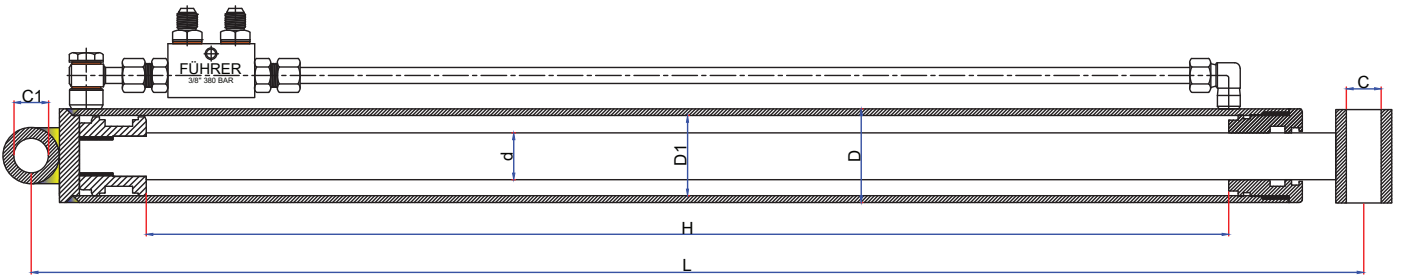

TEKNİK ÖZELLİKLER

Stok Kodu	Ürün Cinsi	Kapasite (Ton)	Kapalı Merkez L - (cm)	Strok H-(mm)	Boru Çapı D1-D (mm)	Mil Çapı d- (mm)
FHR-1100	ÇİFT YÖNLÜ KİLİTLİ LİFT	2	40	210	60*70	40
FHR-1101	ÇİFT YÖNLÜ KİLİTLİ LİFT	2	50	310	60*70	40
FHR-1102	ÇİFT YÖNLÜ KİLİTLİ LİFT	2	60	410	60*70	40
FHR-1103	ÇİFT YÖNLÜ KİLİTLİ LİFT	2	70	510	60*70	40
FHR-1104	ÇİFT YÖNLÜ KİLİTLİ LİFT	2	80	610	60*70	40
FHR-1105	ÇİFT YÖNLÜ KİLİTLİ LİFT	2	90	710	60*70	40
FHR-1106	ÇİFT YÖNLÜ KİLİTLİ LİFT	2	100	810	60*70	40

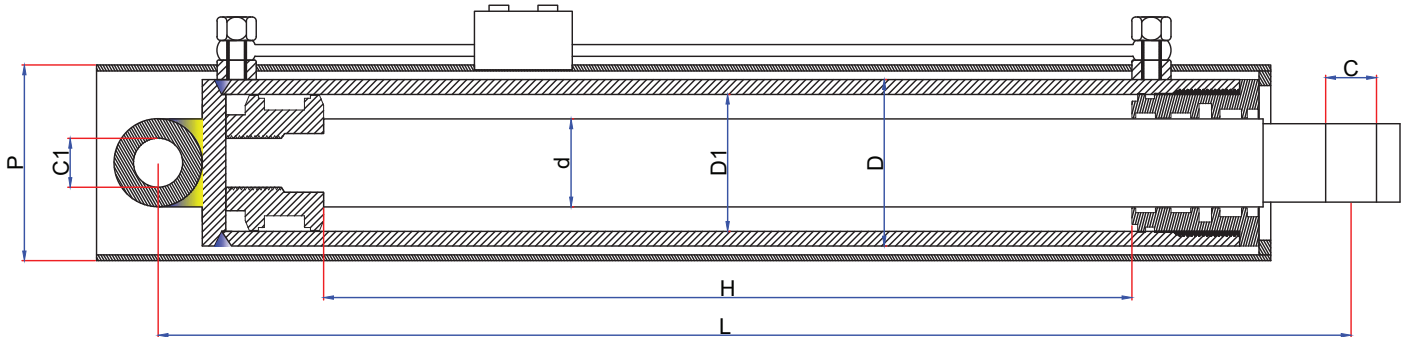
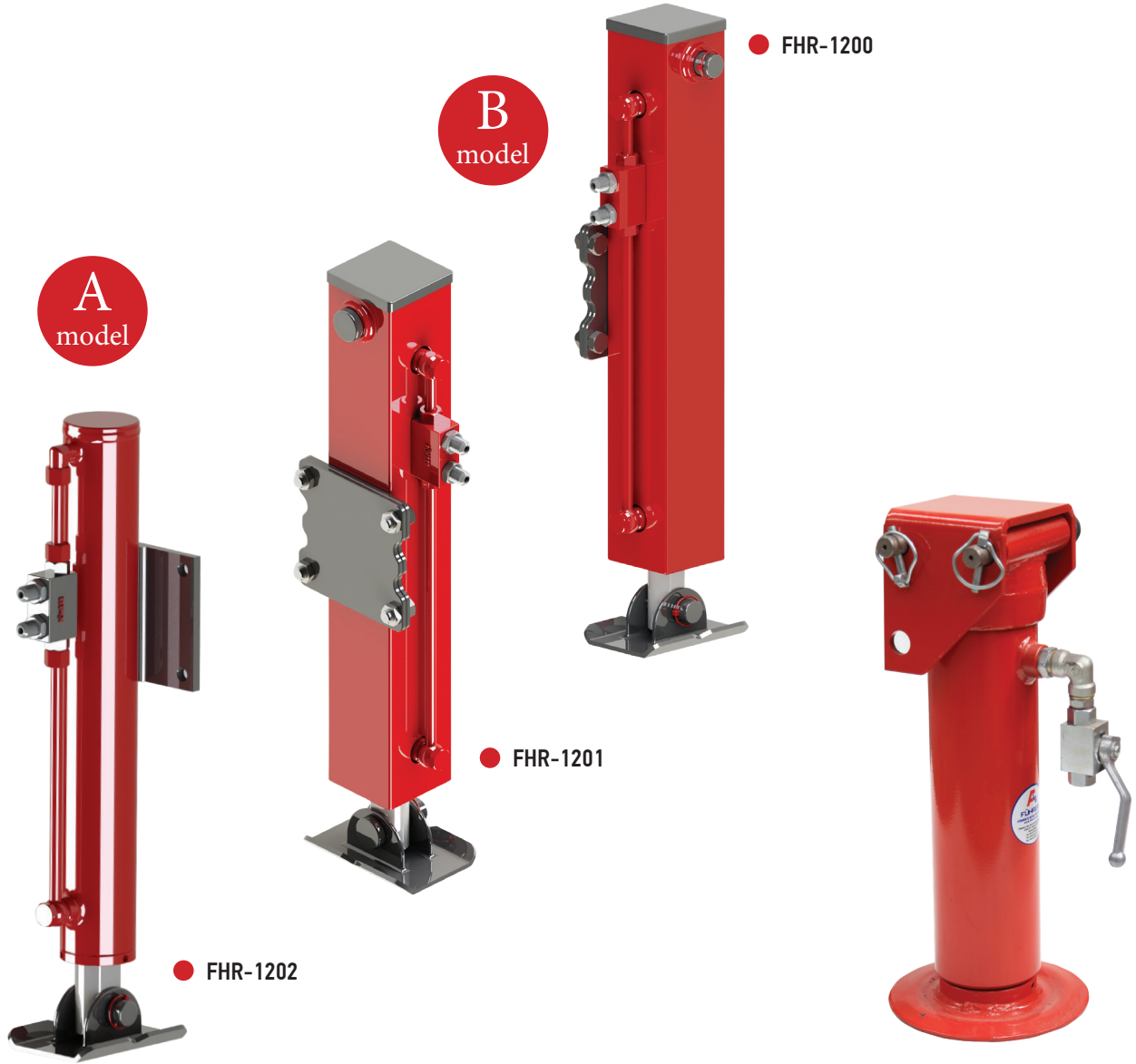

TEKNİK ÖZELLİKLER

Stok Kodu	Ürün Cinsi	Kapasite (Ton)	Kapalı Merkez L - (cm)	Strok H-(mm)	Tip	Profil Ebatı P - (mm)	Boru Çapı D1-D (mm)	Mil Çapı d - (mm)
FHR-1200	HİDROLİK RÖMORK KRİKOLARI	3	61	420	KİLİTLİ	90*90	60*70	40
FHR-1201	HİDROLİK RÖMORK KRİKOLARI	6	61	420	KİLİTLİ	100*100	70*80	45
FHR-1202	HİDROLİK RÖMORK KRİKOLARI	5	59	420	KİLİTLİ	-	63*75	45

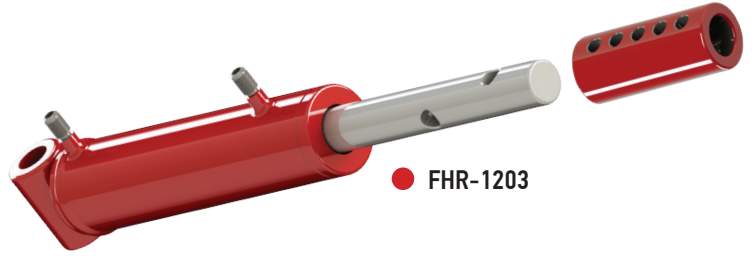

● FHR-1203

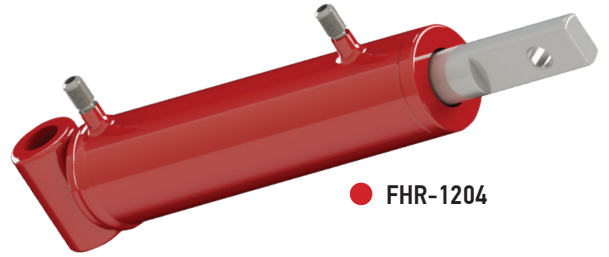

● FHR-1204



● FHR-1205

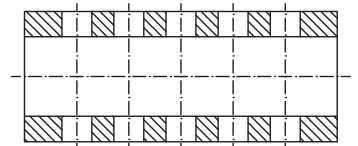
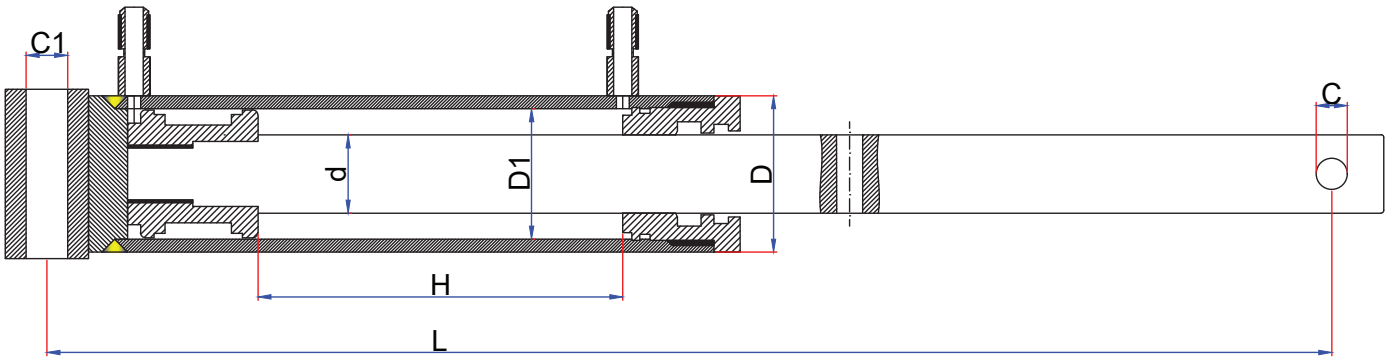

TEKNİK ÖZELLİKLER

Stok Kodu	Ürün Cinsi	Kapalı Merkez L - (cm)	Strok H-(mm)	Boru Çapı D1 - D (mm)	Mil Çapı d- (mm)
FHR-1203	MİBZER LİFTİ	42	140	50*60	30
FHR-1204	MİBZER LİFTİ	33	130	50*60	30
FHR-1205	MİBZER LİFTİ	26	60	50*60	30
FHR-1206	MİBZER LİFTİ TAKIM	47	125	50*60	30



● FHR-1306

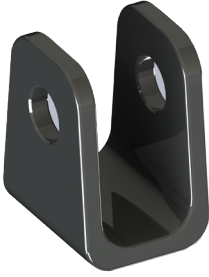
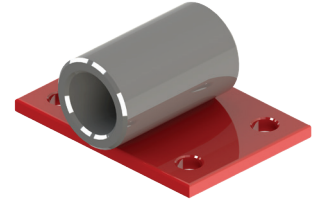

TEKNİK ÖZELLİKLER

Stok Kodu	Ürün Cinsi	Kapalı Merkez L - (cm)	Strok H - (mm)	Boru Çapı D1-D (mm)	Mil Çapı d - (mm)
FHR-1300	DEPO LİFTİ	72.5	830	80*90	40
FHR-1301	DİNGİL LİFTİ	33	170	63*75	40
FHR-1302	TIRMIK LİFTİ	45	300	50*60	30
FHR-1303	TABLA LİFTİ	52.5	330	50*60	25
FHR-1304	FINDIK PATOZ LİFTİ	90	720	60*70	40
FHR-1305	FINDIK PATOZ LİFTİ	70	520	60*70	40
FHR-1306	OK LİFTİ - TAKIMI	66	415	60*70	35
FHR-1307	ÇATALSIZ FREN LİFTİ	30	120	40*50	20
FHR-1308	ÇATALLI FREN LİFTİ	29	120	40*50	20
FHR-1309	KLAVUZ MARKÖR LİFTİ	48.5	210	32*40	18
FHR-1310	SEPET LİFTİ	70	300	50*60	30
FHR-1311	GOBLE LİFTİ	59	335	90*105	50
FHR-1312	RÖMORK KAPAK LİFTİ	60	420	50*60	30
FHR-1313	RÖMORK KAPAK LİFTİ	70	520	50*60	30
FHR-1314	RÖMORK KAPAK LİFTİ	80	620	50*60	30

HİDROLİK TARIM LİFTLERİ



● FHR-1300



● FHR-1301



● FHR-1302



● FHR-1312 - FHR-1313 - FHR-1314



● FHR-1303



● FHR-1307 / FHR-1308



● FHR-1304 / FHR-1305



● FHR-1309

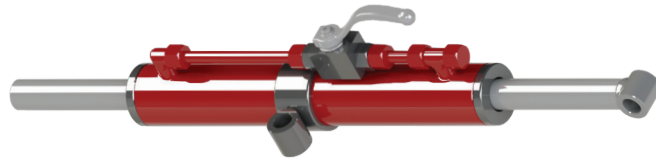

● FHR-1310



● FHR-1311

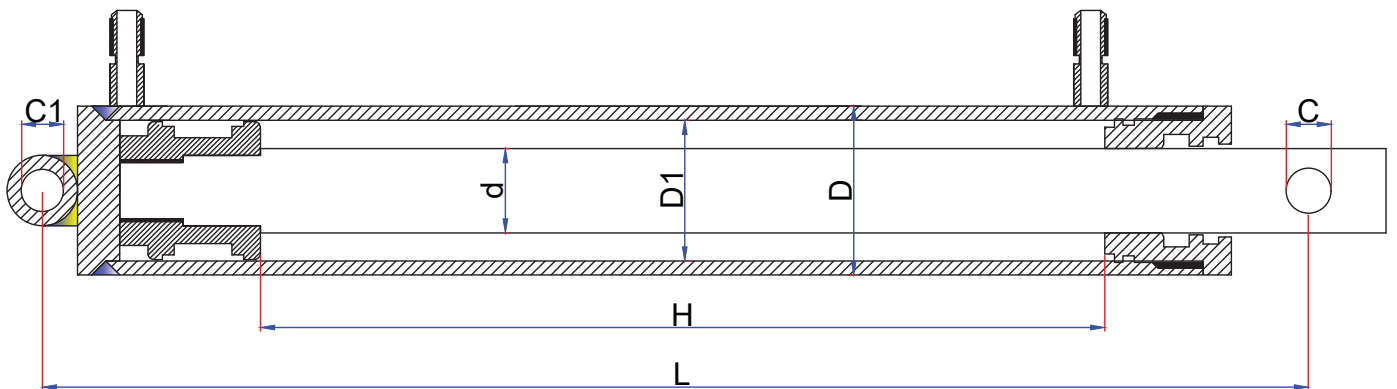

FHR-1400

DESTEK KİT TAKIMLARI



TÜMOSAN



TEKNİK ÖZELLİKLER

Stok Kodu	Ürün Cinsi	Uyumlu Modeller
FHR-1400	TÜMOSAN DESTEK KİT TAKIMI	7000 - 8000

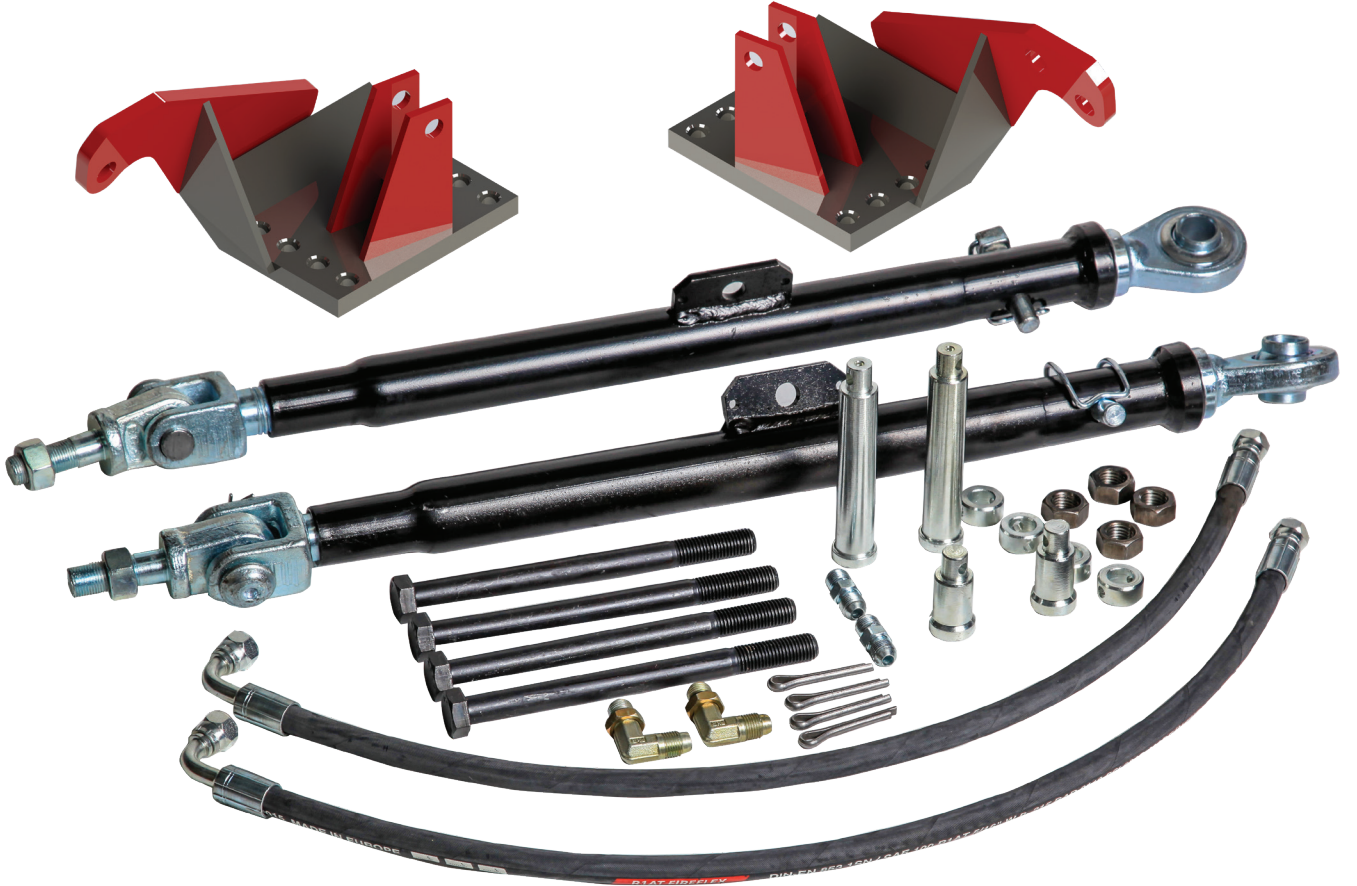
**TEKNİK ÖZELLİKLER**

Stok Kodu	Ürün Cinsi	Uyumlu Modeller
FHR-1401	MASSEY FERGUSON DESTEK KİT TAKIMI	265-285-266G-277G-288G-286G-398-3075-3085-3095-3105

FHR-1402

DESTEK KİT TAKIMLARI



JOHN DEERE



TEKNİK ÖZELLİKLER

Stok Kodu	Ürün Cinsi	Uyumlu Modeller
FHR-1402	JOHNDEERE DESTEK KİT TAKIMI	5050-5060-5065-5075E-5625-2725-5083E-5093E

**TEKNİK ÖZELLİKLER**

Stok Kodu	Ürün Cinsi	Uyumlu Modeller
FHR-1403	FORD DESTEK KİT TAKIMI	3000-3600-5000-5600-6600-6610-6640-7000-7610-7740

FHR-1404

DESTEK KİT TAKIMLARI



TEKNİK ÖZELLİKLER

Stok Kodu	Ürün Cinsi	Uyumlu Modeller
FHR-1404	NEW HOLLAND DESTEK KİT TAKIMI	TD75-TD90-TD100-TD110-BLUEMASTER

FHR-1405

DESTEK KİT TAKIMLARI



TEKNİK ÖZELLİKLER

Stok Kodu	Ürün Cinsi	Uyumlu Modeller
FHR-1405	NEW HOLLAND DESTEK KİT TAKIMI	TD65-TD75-TD85-TD90-TD95-TD100



DİKKATLİ BAKARSAŒ BİZİ HERYERDE GÖRÜRSÜN

IF YOU LOOK CAREFULLY, YOU SEE US
EVERYWHERE



TEKNİK ÖZELLİKLER

Stok Kodu	Tip	Rakor	Litre
FHR-1500	M-40 1P	3/8"-1/2"	40
FHR-1501	M-45 1P	3/8"-1/2"	45
FHR-1502	M-45 2P	3/8"-1/2"	45
FHR-1503	M-45 3P	3/8"-1/2"	45
FHR-1504	M-45 4P	3/8"-1/2"	45
FHR-1505	M-45 5P	3/8"-1/2"	45
FHR-1506	M-45 6P	3/8"-1/2"	45
FHR-1507	MS-45 1P	3/8"-1/2"	45
FHR-1508	MS-45 2P	3/8"-1/2"	45
FHR-1509	MS-45 3P	3/8"-1/2"	45
FHR-1510	MS-45 4P	3/8"-1/2"	45
FHR-1511	MS-45 5P	3/8"-1/2"	45
FHR-1512	MS-45 6P	3/8"-1/2"	45
FHR-1513	MS-45 7P	3/8"-1/2"	45
FHR-1514	M-70 1P	1/2"-3/4"	70
FHR-1515	M-70 2P	1/2"-3/4"	70
FHR-1516	M-70 3P	1/2"-3/4"	70
FHR-1517	M-70 4P	1/2"-3/4"	70
FHR-1518	M-70 5P	1/2"-3/4"	70
FHR-1519	M-70 6P	1/2"-3/4"	70
FHR-1520	M-80 1P	1/2"-3/4"	80
FHR-1521	M-80 2P	1/2"-3/4"	80
FHR-1522	M-80 3P	1/2"-3/4"	80
FHR-1523	M-80 4P	1/2"-3/4"	80
FHR-1524	M-80 5P	1/2"-3/4"	80
FHR-1525	M-80 6P	1/2"-3/4"	80





TEKNİK ÖZELLİKLER

Stok Kodu	Tip	Rakor	Litre
FHR-1600	PD-80 1P	3/4"-1" 1/2"-3/4"	80
FHR-1601	PD-80 2P	1/2"-3/4"	80
FHR-1602	PD-80 3P	1/2"-3/4"	80
FHR-1603	PD-80 4P	1/2"-3/4"	80
FHR-1604	PD-80 5P	1/2"-3/4"	80
FHR-1605	PD-80 6P	1/2"-3/4"	80
FHR-1606	PD-80 7P	1/2"-3/4"	80
FHR-1607	PD-80 8P	1/2"-3/4"	80
FHR-1608	PD-80 9P	1/2"-3/4"	80
FHR-1609	PD-80 10P	1/2"-3/4"	80
FHR-1610	PD-80 11P	1/2"-3/4"	80
FHR-1611	PD-80 12P	1/2"-3/4"	80
FHR-1612	PD-100 1P	1/2"-3/4"	100
FHR-1613	PD-100 2P	1/2"-3/4"	100
FHR-1614	PD-100 3P	1/2"-3/4"	100
FHR-1615	PD-100 4P	1/2"-3/4"	100
FHR-1616	PD-100 5P	1/2"-3/4"	100
FHR-1617	PD-100 6P	1/2"-3/4"	100
FHR-1618	PD-100 7P	1/2"-3/4"	100
FHR-1619	PD-100 8P	1/2"-3/4"	100
FHR-1620	PD-100 9P	1/2"-3/4"	100
FHR-1621	PD-100 10P	1/2"-3/4"	100
FHR-1622	PD-100 11P	1/2"-3/4"	100
FHR-1623	PD-100 12P	1/2"-3/4"	100
FHR-1624	PD-120 1P	1/2"-3/4"	120
FHR-1625	PD-120 2P	1/2"-3/4"	120
FHR-1626	PD-120 3P	1/2"-3/4"	120
FHR-1627	PD-120 4P	1/2"-3/4"	120
FHR-1628	PD-120 5P	1/2"-3/4"	120
FHR-1629	PD-120 6P	1/2"-3/4"	120

TEKNİK ÖZELLİKLER

Stok Kodu	Tip	Rakor	Litre
FHR-1630	PD-120 7P	1/2"-3/4"	120
FHR-1631	PD-120 8P	1/2"-3/4"	120
FHR-1632	PD-120 9P	1/2"-3/4"	120
FHR-1633	PD-120 10P	1/2"-3/4"	120
FHR-1634	PD-120 11P	1/2"-3/4"	120
FHR-1635	PD-120 12P	1/2"-3/4"	120
FHR-1636	PD-150 1P	3/4"-1"	150
FHR-1637	PD-150 2P	3/4"-1"	150
FHR-1638	PD-150 3P	3/4"-1"	150
FHR-1639	PD-150 4P	3/4"-1"	150
FHR-1640	PD-150 5P	3/4"-1"	150
FHR-1641	PD-150 6P	3/4"-1"	150
FHR-1642	PD-150 7P	3/4"-1"	150
FHR-1643	PD-150 8P	3/4"-1"	150
FHR-1644	PD-150 9P	3/4"-1"	150
FHR-1645	PD-150 10P	3/4"-1"	150
FHR-1646	PD-150 11P	3/4"-1"	150
FHR-1647	PD-150 12P	3/4"-1"	150

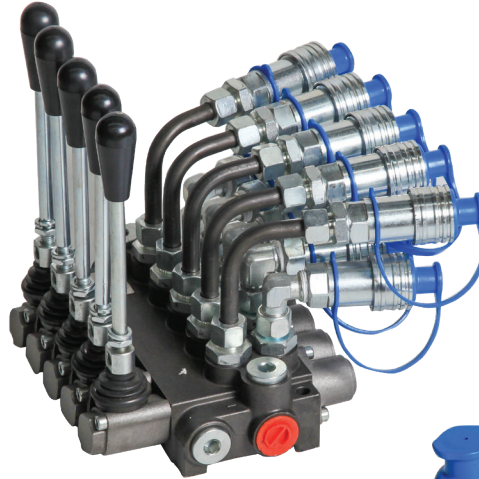
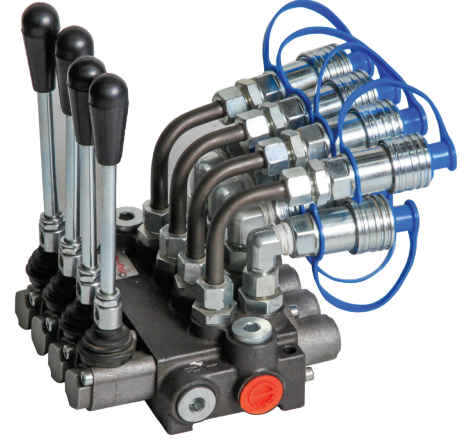

TEKNİK ÖZELLİKLER

Stok Kodu	Ürün Cinsi	Rakor	Litre (Lt)
FHR-1526	FHR-M-45 1P	3/8"-1/2"	45
FHR-1527	FHR-M-45 2P	3/8"-1/2"	45
FHR-1528	FHR-M-45 3P	3/8"-1/2"	45
FHR-1529	FHR-M-45 4P	3/8"-1/2"	45
FHR-1530	FHR-M-45 5P	3/8"-1/2"	45

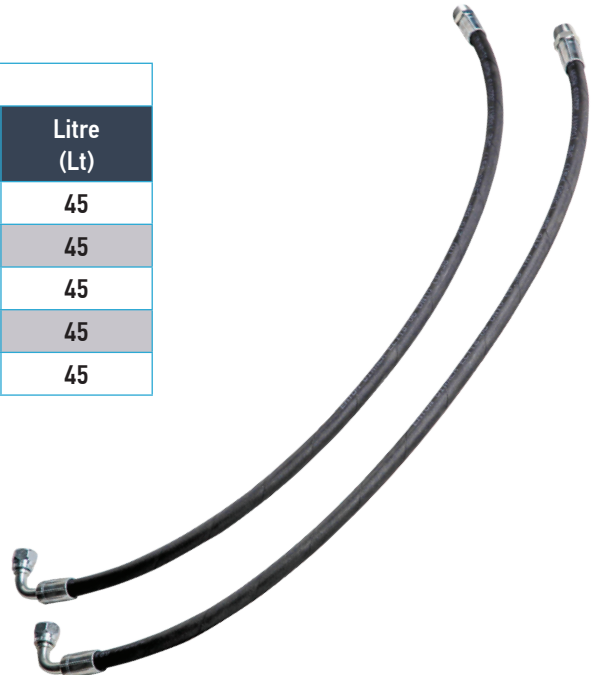



TEKNİK ÖZELLİKLER

Stok Kodu	Ürün Cinsi	Rakor	Oem Kodu	Marka	Model
FHR-1665	Damper Kaldırma Seti 4 Çıkış	18 x 1,50	47574798	New Holland	TT Serisi -55 / 65 S
FHR-1666	FHR-TV-50-1P - 2 Çıkış	18 x 1,50		New Holland-Tümosan	
FHR-1667	FHR-TV-50-2P - 4 Çıkış	18 x 1,50		New Holland-Tümosan	
FHR-1668	FHR-TV-50-3P - 6 Çıkış	18 x 1,50		New Holland-Tümosan	

FHR-1669

MF KUMANDA KOLLARI



TEKNİK ÖZELLİKLER

Stok Kodu	Ürün Cinsi	Rakor	Litre (Lt)
FHR-1669	FHR-DMF-1P	M22x1,5	-
FHR-1670	FHR-DMF-2P	M22x1,5	-
FHR-1671	FHR-DMF-3P	M22x1,5	-

● FHR-2304

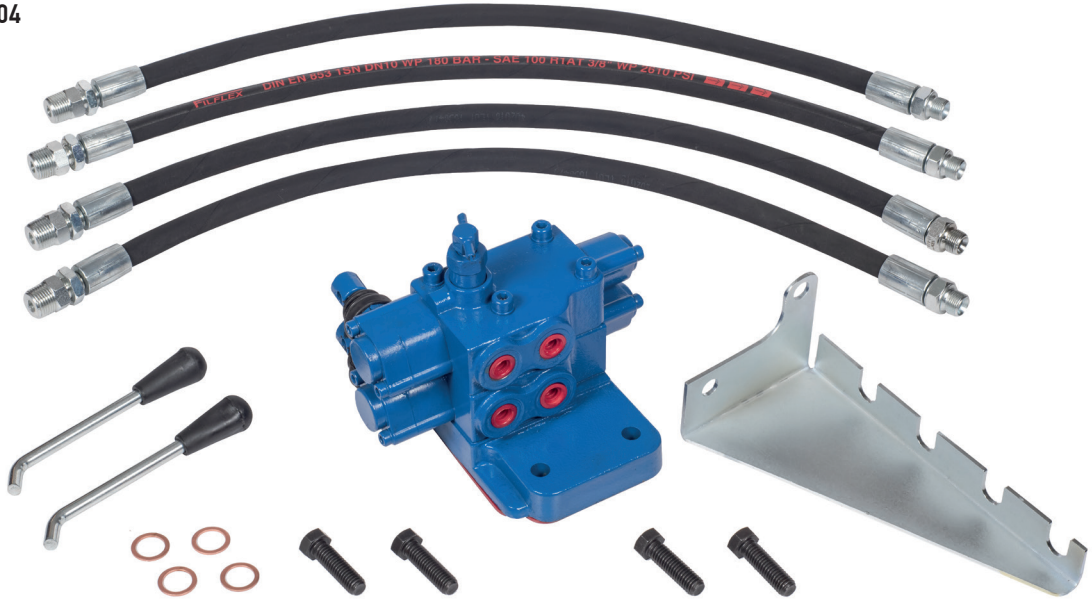

● FHR-2301

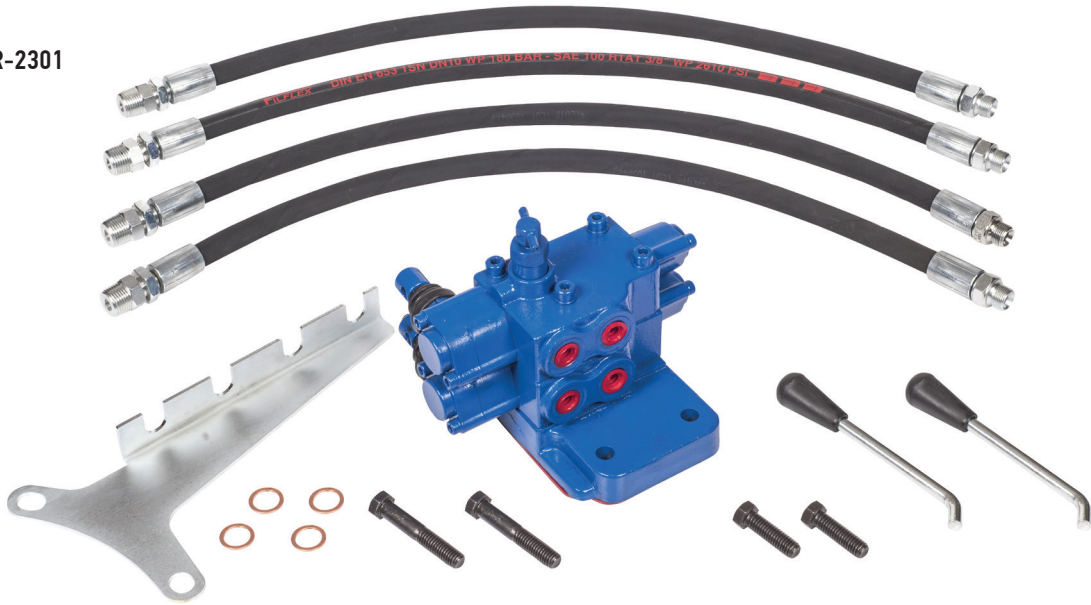

TEKNİK ÖZELLİKLER

Stok Kodu	Ürün Cinsi	Çıkış Sayısı	Rakor
FHR-2300	FORD 3000	İKİ ÇIKIŞ	3/8
FHR-2301	FORD 3000	DÖRT ÇIKIŞ	3/8
FHR-2302	FORD 3000	ALTI ÇIKIŞ	3/8
FHR-2303	FORD 5000	İKİ ÇIKIŞ	3/8
FHR-2304	FORD 5000	DÖRT ÇIKIŞ	3/8
FHR-2305	FORD 5000	ALTI ÇIKIŞ	3/8

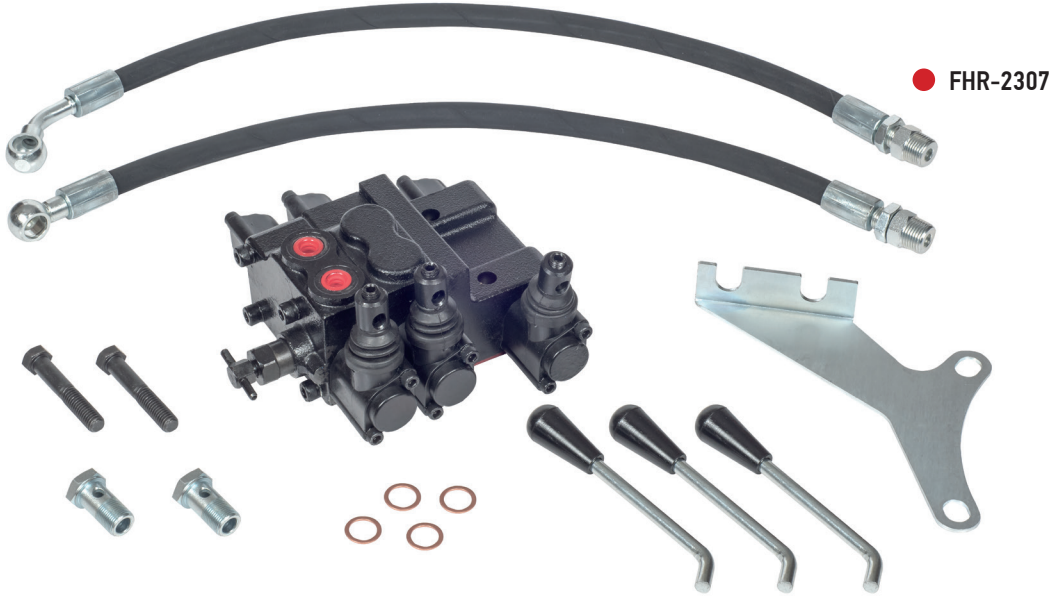
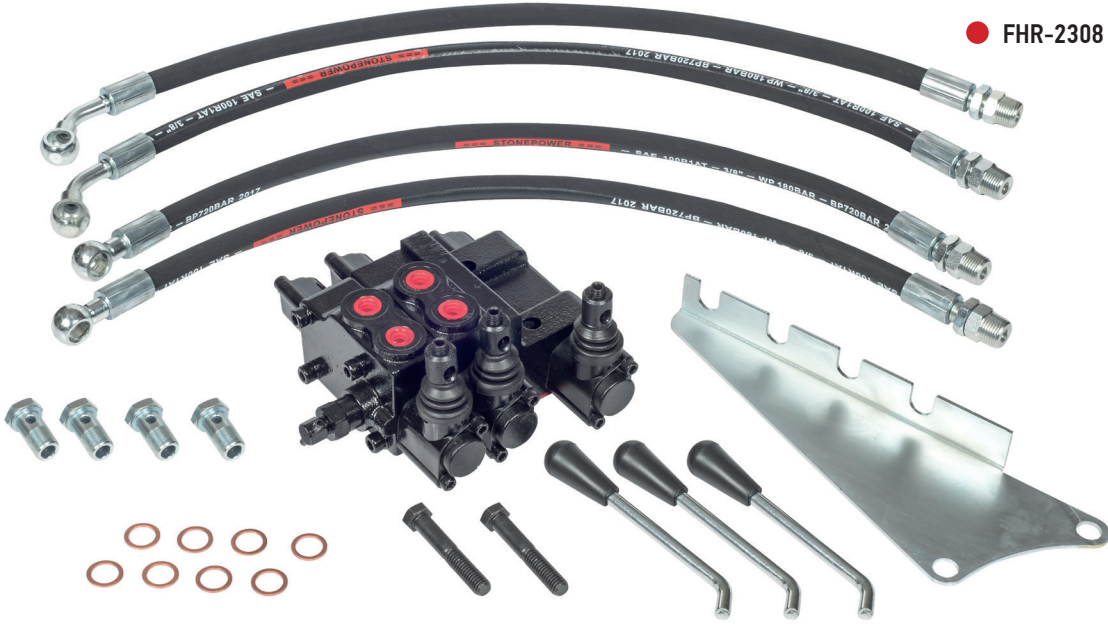

TEKNİK ÖZELLİKLER

Stok Kodu	Ürün Cinsi	Çıkış Sayısı	Rakor
FHR-2306	MASSEY FERGUSON	İKİ ÇIKIŞ	3/8
FHR-2307	MASSEY FERGUSON	İKİ ÇIKIŞ + HİDROLİK	3/8
FHR-2308	MASSEY FERGUSON	DÖRT ÇIKIŞ	3/8
FHR-2309	MASSEY FERGUSON	DÖRT ÇIKIŞ + HİDROLİK	3/8
FHR-2310	MASSEY FERGUSON	ALTI ÇIKIŞ	3/8

FHR-2311

FIAT-DAMPER VALFLERİ



● FHR-2312

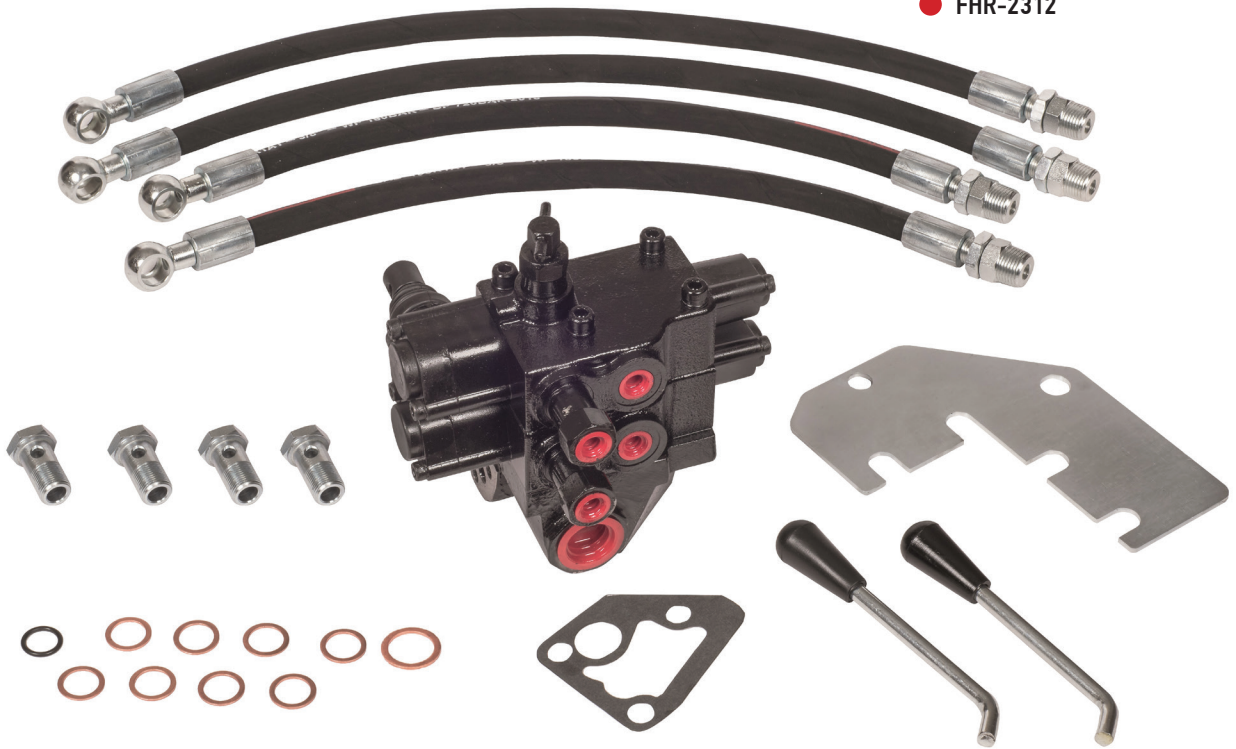

TEKNİK ÖZELLİKLER

Stok Kodu	Ürün Cinsi	Çıkış Sayısı	Rakor
FHR-2311	FIAT	İKİ ÇIKIŞ	3/8
FHR-2312	FIAT	DÖRT ÇIKIŞ	3/8
FHR-2313	FIAT	ALTI ÇIKIŞ	3/8

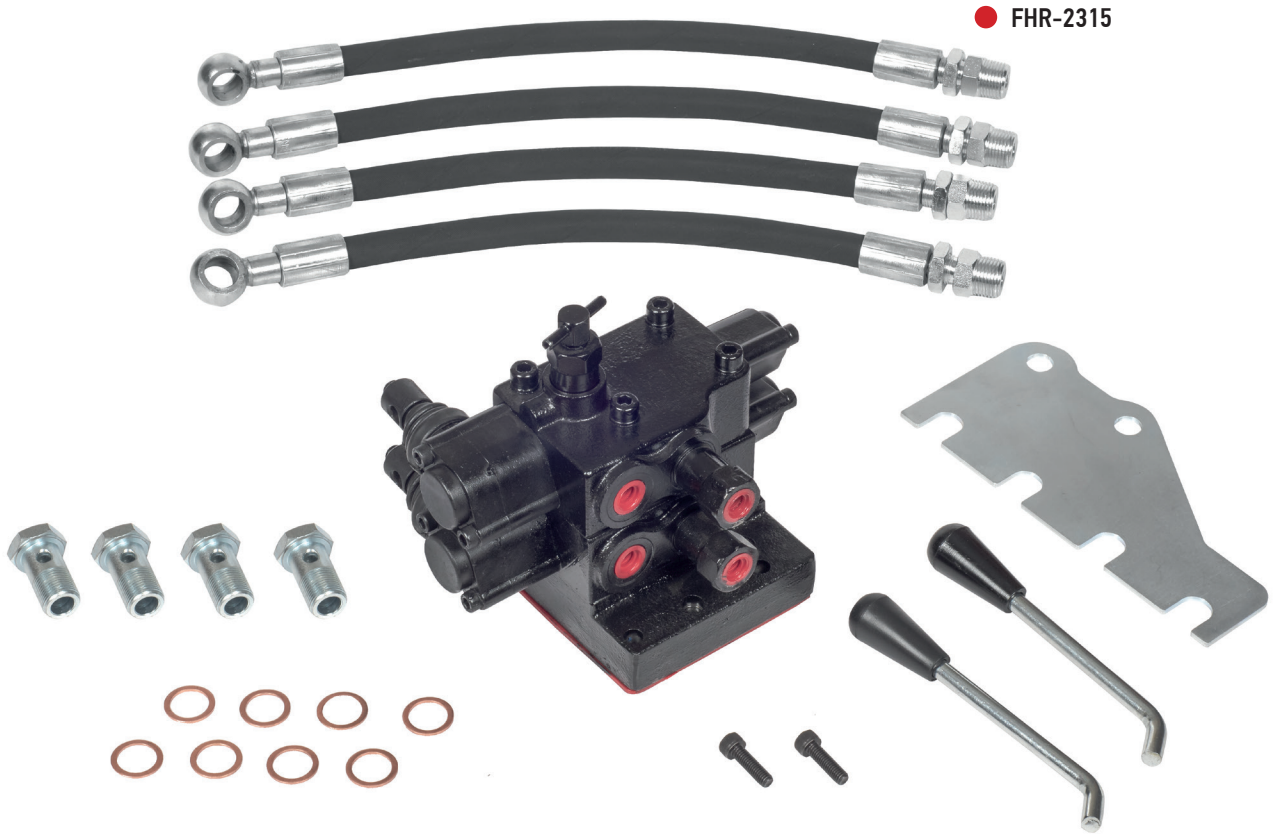
**TEKNİK ÖZELLİKLER**

Stok Kodu	Ürün Cinsi	Çıkış Sayısı	Rakor
FHR-2314	STEYR	İKİ ÇIKIŞ	3/8
FHR-2315	STEYR	DÖRT ÇIKIŞ	3/8
FHR-2316	STEYR	ALTI ÇIKIŞ	3/8

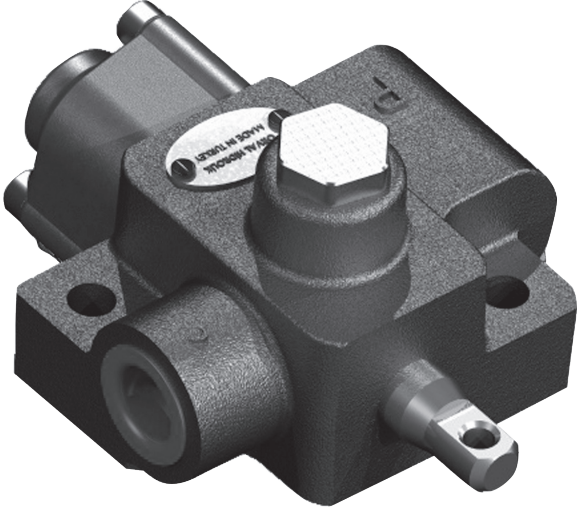

**TEKNİK ÖZELLİKLER**

Stok Kodu	Ürün Cinsi	Rakor	Litre (Lt)
FHR-1672	FHR-RSV-45 - VENTİL	1/2	



● FHR-1704

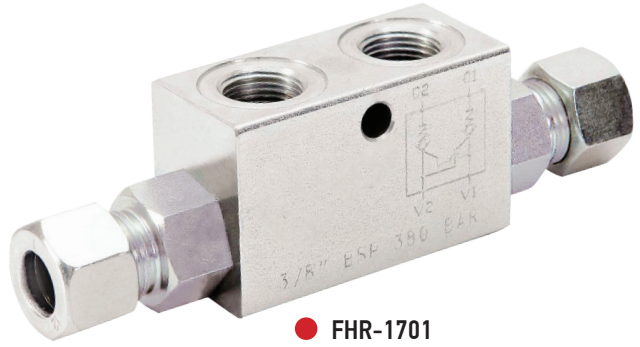

● FHR-1701

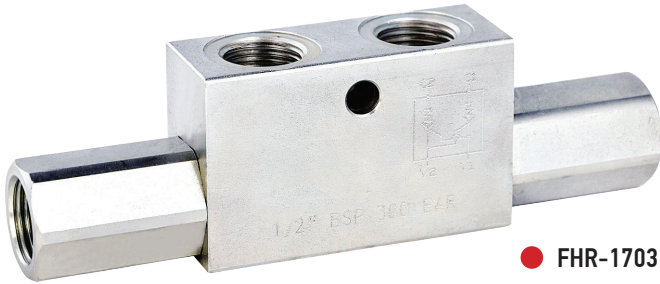

● FHR-1703

TEKNİK ÖZELLİKLER

Stok Kodu	Ürün Cinsi
FHR-1700	1/4 İKİZ KİLİTLEME VALFİ
FHR-1701	3/8 SOMUNLU İKİZ KİLİTLEME VALFİ
FHR-1702	1/2 İKİZ KİLİTLEME VALFİ
FHR-1703	3/8 SOMUNSUZ İKİZ KİLİTLEME VALFİ
FHR-1704	1/2 BASINÇ EMNİYET VALFİ

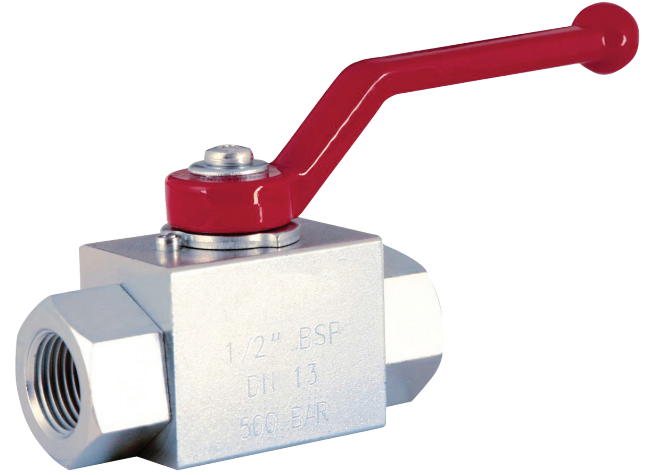

TEKNİK ÖZELLİKLER

Stok Kodu	Ürün Cinsi
FHR-1705	1/4 HİDROLİK KÜRESEL VANA
FHR-1706	3/8 HİDROLİK KÜRESEL VANA
FHR-1707	1/2 HİDROLİK KÜRESEL VANA
FHR-1708	3/4 HİDROLİK KÜRESEL VANA
FHR-1709	1" HİDROLİK KÜRESEL VANA
FHR-1710	1-1/4 HİDROLİK KÜRESEL VANA
FHR-1711	1-1/2 HİDROLİK KÜRESEL VANA



TEKNİK ÖZELLİKLER

Stok Kodu	Ürün Cinsi
FHR-1712	1/4 HİDROLİK KÜRESEL VANA
FHR-1713	3/8 HİDROLİK KÜRESEL VANA
FHR-1714	1/2 HİDROLİK KÜRESEL VANA
FHR-1715	3/4 HİDROLİK KÜRESEL VANA
FHR-1716	1" HİDROLİK KÜRESEL VANA
FHR-1717	1-1/4 HİDROLİK KÜRESEL VANA
FHR-1718	1-1/2 HİDROLİK KÜRESEL VANA

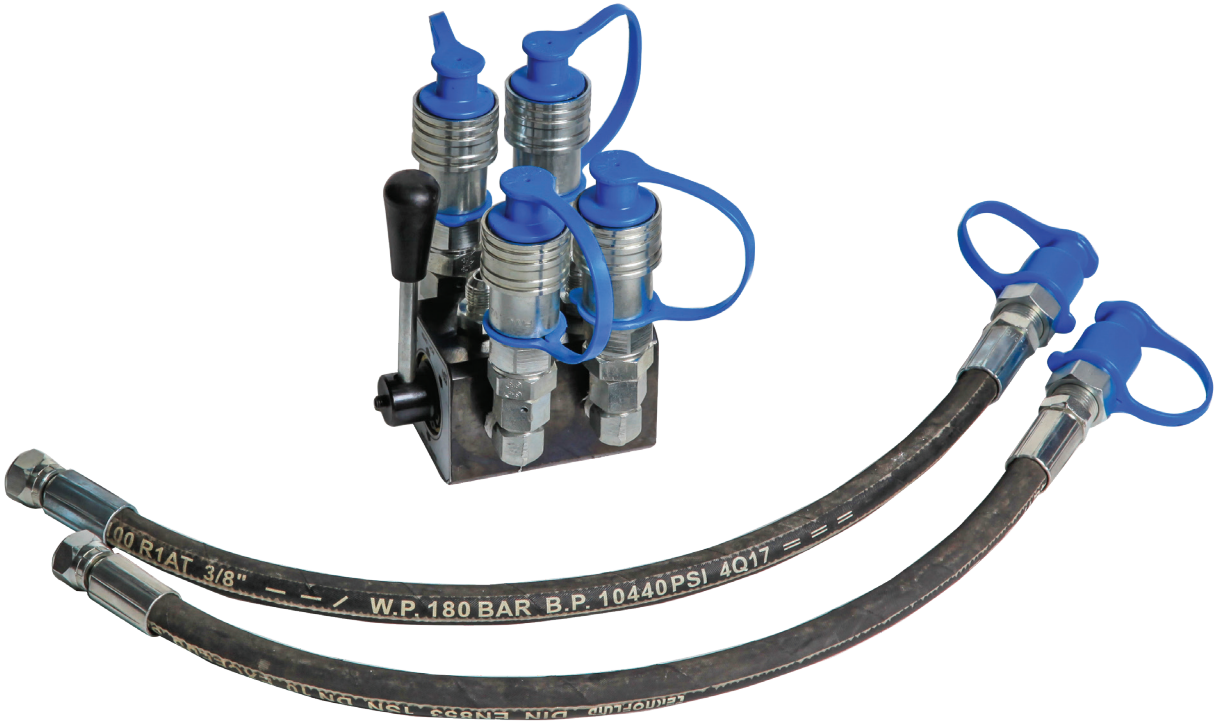
**TEKNİK ÖZELLİKLER**

Stok Kodu	Ürün Cinsi
FHR-1719	3/8 HİDROLİK ALTI YOLLU VANA-TAKIM
FHR-1720	3/8 HİDROLİK ALTI YOLLU VANA

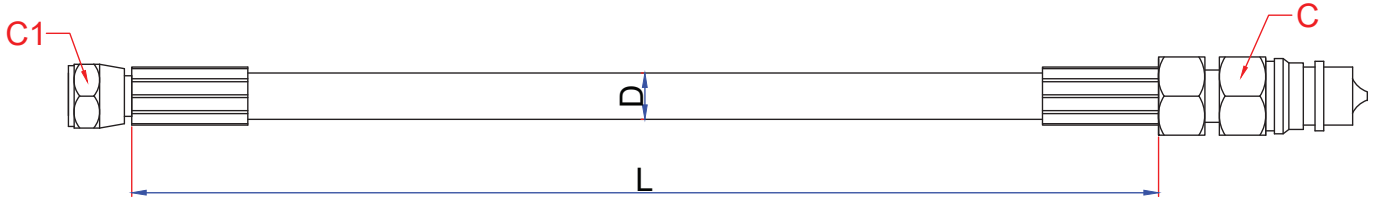
**TEKNİK ÖZELLİKLER**

Stok Kodu	Ürün Cinsi - D	Boy L (cm)
FHR-1800	3/8 R1-R2 HORTUM	30
FHR-1801	3/8 R1-R2 HORTUM	65
FHR-1802	3/8 R1-R2 HORTUM	70
FHR-1803	3/8 R1-R2 HORTUM	130
FHR-1804	3/8 R1-R2 HORTUM	170
FHR-1805	3/8 R1-R2 HORTUM	200
FHR-1806	3/8 R1-R2 HORTUM	250
FHR-1807	3/8 R1-R2 HORTUM	300

R1 ve R2 HORTUM ürünleri isteğe bağlı üretilmekte olup fiyat değişikliği göstermektedir. Siparişleriniz öncesinde ürün koduna göre fiyat sorunuz.

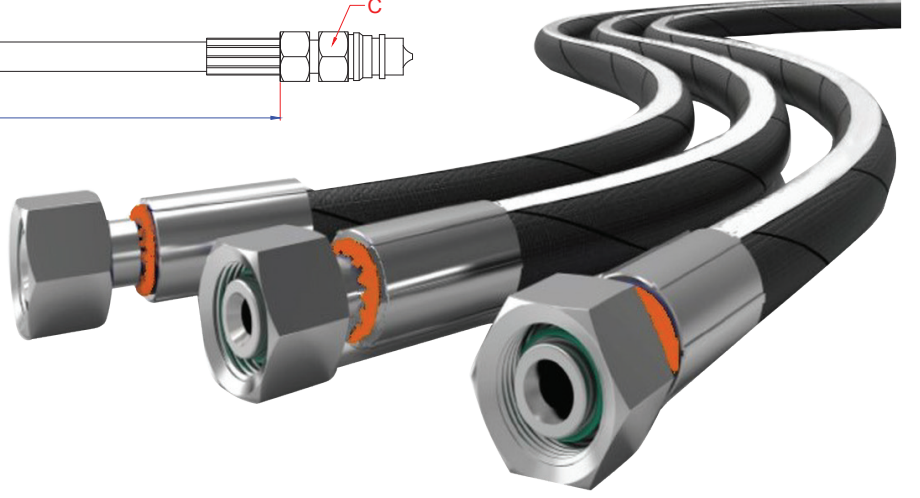
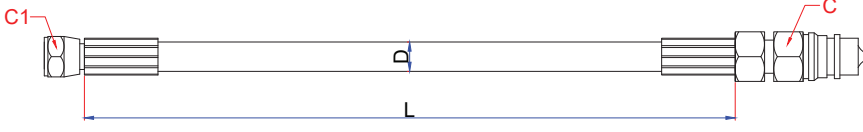

R1 ve R2 HORTUM ürünleri isteğe bağlı üretilmekte olup fiyat değişikliği göstermektedir. Siparişleriniz öncesinde ürün koduna göre fiyat sorunuz.

TEKNİK ÖZELLİKLER

Stok Kodu	Ürün Cinsi - D	Boy L (cm)
FHR-1825	3/8 R1-R2 HORTUM	30 CM
FHR-1826	3/8 R1-R2 HORTUM	35 CM
FHR-1827	3/8 R1-R2 HORTUM	40 CM
FHR-1828	3/8 R1-R2 HORTUM	45 CM
FHR-1829	3/8 R1-R2 HORTUM	50 CM
FHR-1830	3/8 R1-R2 HORTUM	55 CM
FHR-1831	3/8 R1-R2 HORTUM	60 CM
FHR-1832	3/8 R1-R2 HORTUM	65 CM
FHR-1833	3/8 R1-R2 HORTUM	70 CM
FHR-1834	3/8 R1-R2 HORTUM	75 CM
FHR-1835	3/8 R1-R2 HORTUM	80 CM
FHR-1836	3/8 R1-R2 HORTUM	85 CM
FHR-1837	3/8 R1-R2 HORTUM	90 CM
FHR-1838	3/8 R1-R2 HORTUM	95 CM
FHR-1839	3/8 R1-R2 HORTUM	100 CM
FHR-1840	3/8 R1-R2 HORTUM	105 CM
FHR-1841	3/8 R1-R2 HORTUM	110 CM
FHR-1842	3/8 R1-R2 HORTUM	115 CM
FHR-1843	3/8 R1-R2 HORTUM	120 CM
FHR-1844	3/8 R1-R2 HORTUM	125 CM
FHR-1845	3/8 R1-R2 HORTUM	130 CM
FHR-1846	3/8 R1-R2 HORTUM	135 CM
FHR-1847	3/8 R1-R2 HORTUM	140 CM
FHR-1848	3/8 R1-R2 HORTUM	145 CM
FHR-1849	3/8 R1-R2 HORTUM	150 CM
FHR-1850	3/8 R1-R2 HORTUM	155 CM

TEKNİK ÖZELLİKLER

Stok Kodu	Ürün Cinsi - D	Boy L (cm)
FHR-1851	3/8 R1-R2 HORTUM	160 CM
FHR-1852	3/8 R1-R2 HORTUM	165 CM
FHR-1853	3/8 R1-R2 HORTUM	170 CM
FHR-1854	3/8 R1-R2 HORTUM	175 CM
FHR-1855	3/8 R1-R2 HORTUM	180 CM
FHR-1856	3/8 R1-R2 HORTUM	185 CM
FHR-1857	3/8 R1-R2 HORTUM	190 CM
FHR-1858	3/8 R1-R2 HORTUM	195 CM
FHR-1859	3/8 R1-R2 HORTUM	200 CM
FHR-1860	3/8 R1-R2 HORTUM	250 CM
FHR-1861	3/8 R1-R2 HORTUM	300 CM
FHR-1862	3/8 R1-R2 HORTUM	350 CM
FHR-1863	3/8 R1-R2 HORTUM	400 CM
FHR-1864	3/8 R1-R2 HORTUM	450 CM
FHR-1865	3/8 R1-R2 HORTUM	500 CM
FHR-1866	3/8 R1-R2 HORTUM	550 CM
FHR-1867	3/8 R1-R2 HORTUM	600 CM
FHR-1868	3/8 R1-R2 HORTUM	650 CM
FHR-1869	3/8 R1-R2 HORTUM	700 CM
FHR-1870	3/8 R1-R2 HORTUM	750 CM
FHR-1871	3/8 R1-R2 HORTUM	800 CM
FHR-1872	3/8 R1-R2 HORTUM	850 CM
FHR-1873	3/8 R1-R2 HORTUM	900 CM
FHR-1874	3/8 R1-R2 HORTUM	950 CM
FHR-1875	3/8 R1-R2 HORTUM	1000 CM



● FHR-2401



● FHR-2400

**TEKNİK ÖZELLİKLER**

Stok Kodu	Ürün Cinsi	OEM
FHR-2400	FIAT 450-480-500-540-580-600-640-55.46-65.46	588771
FHR-2401	MF VFD1104	1860100M95

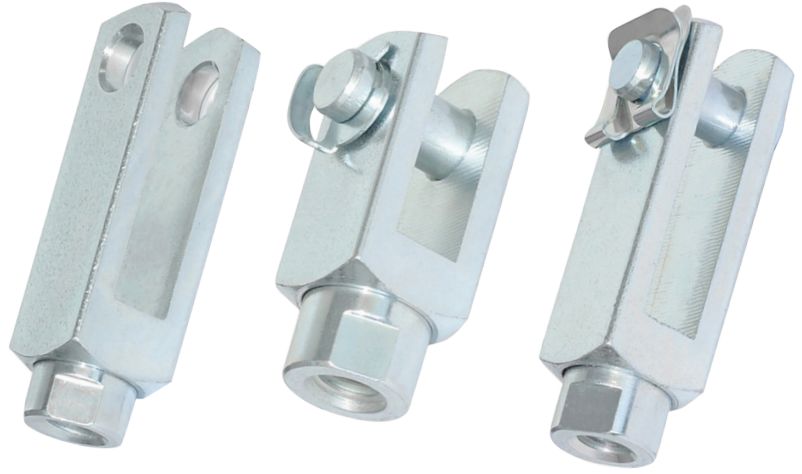

TEKNİK ÖZELLİKLER

Stok Kodu	Ürün Cinsi
FHR-1910	M8X1.25 KLİPSLİ ÇATAL BAĞLANTI
FHR-1911	M10X1.25 KLİPSLİ ÇATAL BAĞLANTI
FHR-1912	M12X1.25 KLİPSLİ ÇATAL BAĞLANTI
FHR-1913	M16X1.5 KLİPSLİ ÇATAL BAĞLANTI
FHR-1914	M20X1.5 KLİPSLİ ÇATAL BAĞLANTI
FHR-1915	M27X2 KLİPSLİ ÇATAL BAĞLANTI



TEKNİK ÖZELLİKLER

Stok Kodu	Ürün Cinsi	Diş Ölçüsü	Pim Ölçüsü
FHR-1916	Q 12/16 PİSTON MAFSAL BAĞLANTI	M6X1.25	6
FHR-1917	Q 20 PİSTON MAFSAL BAĞLANTI	M8X1.25	8
FHR-1918	Q 25/32 PİSTON MAFSAL BAĞLANTI	M10X1.25	10
FHR-1919	Q 40 PİSTON MAFSAL BAĞLANTI	M12X1.25	12
FHR-1920	Q 50 /63 PİSTON MAFSAL BAĞLANTI	M16X1.5	16
FHR-1921	Q 80/100 PİSTON MAFSAL BAĞLANTI	M20X1.5	20
FHR-1922	Q 125 PİSTON MAFSAL BAĞLANTI	M30X2.0	30
FHR-1923	Q 160/200 PİSTON MAFSAL BAĞLANTI	M35X2.0	35

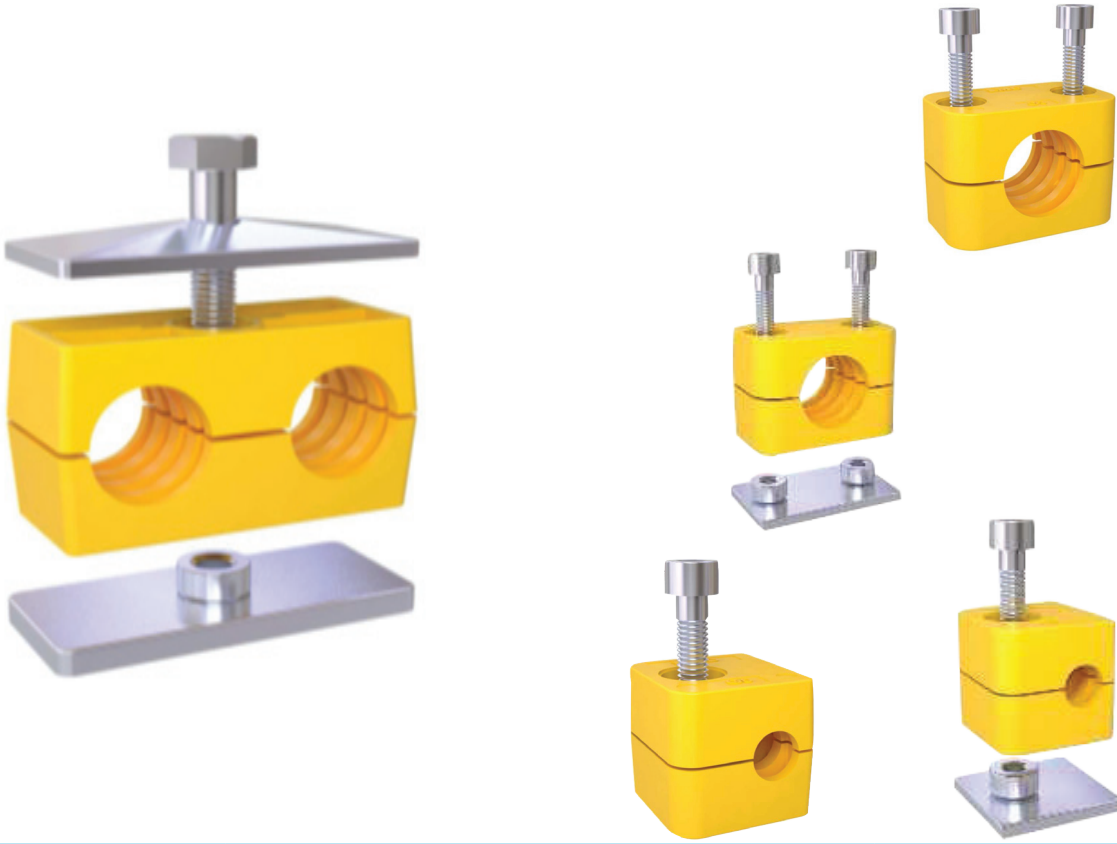

TEKNİK ÖZELLİKLER

Stok Kodu	Ürün Cinsi	Hortum Çapı (mm)	Ürün Cinsi
FHR-1924	BORU VE HORTUM KELEPÇESİ	6	TEKLİ
FHR-1925	BORU VE HORTUM KELEPÇESİ	8	TEKLİ
FHR-1926	BORU VE HORTUM KELEPÇESİ	10	TEKLİ
FHR-1927	BORU VE HORTUM KELEPÇESİ	12	TEKLİ
FHR-1928	BORU VE HORTUM KELEPÇESİ	14	TEKLİ
FHR-1929	BORU VE HORTUM KELEPÇESİ	16	TEKLİ
FHR-1930	BORU VE HORTUM KELEPÇESİ	18	TEKLİ
FHR-1931	BORU VE HORTUM KELEPÇESİ	20	TEKLİ
FHR-1932	BORU VE HORTUM KELEPÇESİ	25	TEKLİ
FHR-1933	BORU VE HORTUM KELEPÇESİ	30	TEKLİ
FHR-1934	BORU VE HORTUM KELEPÇESİ	6	ÇİFTLİ
FHR-1935	BORU VE HORTUM KELEPÇESİ	8	ÇİFTLİ
FHR-1936	BORU VE HORTUM KELEPÇESİ	10	ÇİFTLİ
FHR-1937	BORU VE HORTUM KELEPÇESİ	12	ÇİFTLİ
FHR-1938	BORU VE HORTUM KELEPÇESİ	14	ÇİFTLİ
FHR-1939	BORU VE HORTUM KELEPÇESİ	16	ÇİFTLİ
FHR-1940	BORU VE HORTUM KELEPÇESİ	18	ÇİFTLİ
FHR-1941	BORU VE HORTUM KELEPÇESİ	20	ÇİFTLİ
FHR-1942	BORU VE HORTUM KELEPÇESİ	25	ÇİFTLİ
FHR-1943	BORU VE HORTUM KELEPÇESİ	30	ÇİFTLİ

FHR-1808

RAKOR VE PUL

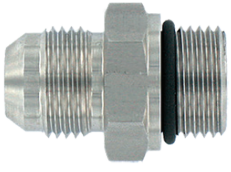

TEKNİK ÖZELLİKLER

Stok Kodu	Ürün Cinsi
FHR-1808	1/2 DİŞİ JAK
FHR-1809	1/2 ERKEK JAK
FHR-1810	1/2 VANA
FHR-1811	3/8-5/8 NİPEL
FHR-1812	3/8-1/4 NİPEL
FHR-1813	1/2-3/4 NİPEL
FHR-1814	1/2-5/8 NİPEL
FHR-1815	3/8-M18 NİPEL

FHR-1816



TEKNİK ÖZELLİKLER

Stok Kodu	Ürün Cinsi
FHR-1816	1/8" BAKIR PUL
FHR-1817	1/4" BAKIR PUL
FHR-1818	3/8" BAKIR PUL
FHR-1819	1/2" BAKIR PUL
FHR-1820	3/4" BAKIR PUL
FHR-1821	1" R" BAKIR PUL
FHR-1822	1-1/4" BAKIR PUL
FHR-1823	1-1/2 R" BAKIR PUL
FHR-1824	2" R" BAKIR PUL



TEKNİK ÖZELLİKLER

Stok Kodu	Ürün Cinsi
FHR-1900	25 CC TULUMBA TİPİ EL POMPASI
FHR-1901	25 CC TEK TESİRLİ EL POMPASI
FHR-1902	25 CC ÇİFT TESİRLİ EL POMPASI
FHR-1903	45 CC TEK TESİRLİ EL POMPASI
FHR-1904	45 CC ÇİFT TESİRLİ EL POMPASI



TEKNİK ÖZELLİKLER

Stok Kodu	Ürün Cinsi
FHR-1905	ALÜMİNYUM DEPO 1LT.
FHR-1906	ALÜMİNYUM DEPO 2LT.
FHR-1907	ALÜMİNYUM DEPO 3LT.
FHR-1908	ALÜMİNYUM DEPO 4LT.
FHR-1909	ALÜMİNYUM DEPO 5LT.

R Victor Taichung

R VTURN NP20

FÜHRER

WARNING



TRAKTÖR KOMPRESÖRÜ

FHR-4600



TEKNİK ÖZELLİKLER

Stok Kodu	Ürün Cinsi
FHR-4600	TRAKTÖR HAVA KOMPRESÖRÜ (YAZAN)
FHR-4601	TRAKTÖR HAVA KOMPRESÖRÜ (FÜHRER)

TRAKTÖR ÇEKİ DEMİRLERİ

FHR-4700

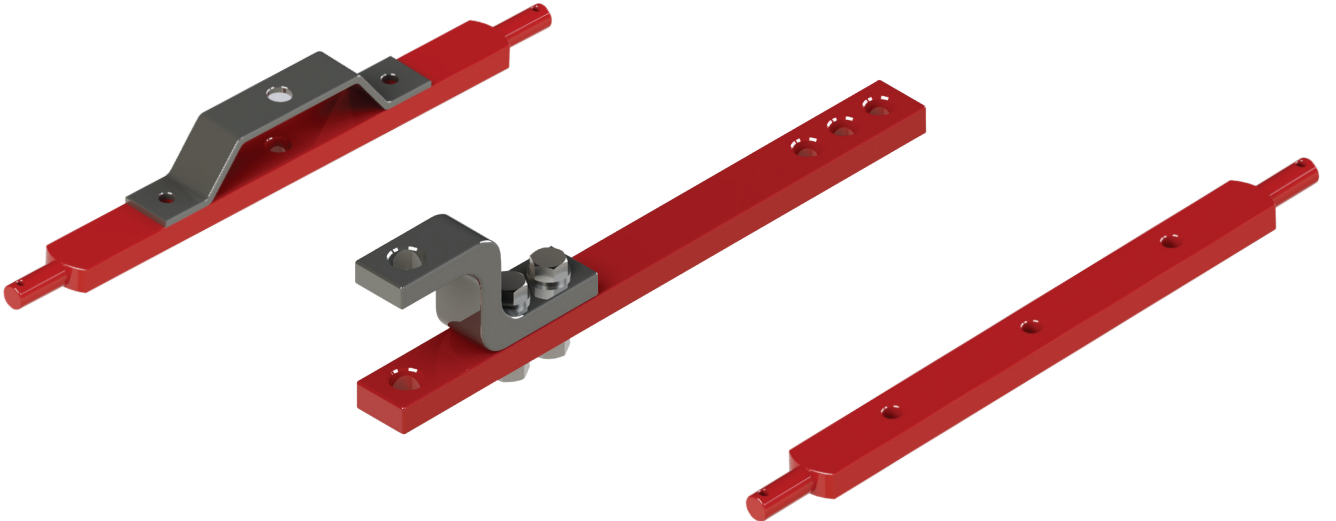

TEKNİK ÖZELLİKLER

Stok Kodu	Ürün Cinsi	Lama Kalınlık (mm)	Lama Eni (mm)	Lama Boyu (mm)
FHR-4700	ÇEKİ OKU	30	60	750
FHR-4701	KÖPRÜLÜ DOKUZ DELİK	30	60	750
FHR-4702	DÜZ DOKUZ DELİK	30	60	750



TEKNİK ÖZELLİKLER

Stok Kodu	Volt	Ürün Cinsi
DZY 12K	12 VOLT	BORU TİP KÜÇÜK DALGIÇ POMPA
DZY 24K	24 VOLT	BORU TİP KÜÇÜK DALGIÇ POMPA
DZY 12B	12 VOLT	BORU TİP BÜYÜK POMPA
DZY 24B	24 VOLT	BORU TİP BÜYÜK POMPA
DZY 12A	12 VOLT	3/4 DIŞTAN ÇEKME ALM. GÖVDE POMPA
DZY 24A	24 VOLT	3/4 DIŞTAN ÇEKME ALM. GÖVDE POMPA
DZY 220D	220 VOLT	3/4 DIŞTAN ÇEKME POMPA
DZY 12-1"	12 VOLT	1" ÇIKIŞLI DIŞTAN ÇEKME POMPA
DZY 24-1"	24 VOLT	1" ÇIKIŞLI DIŞTAN ÇEKME POMPA

Üretim Zinciri

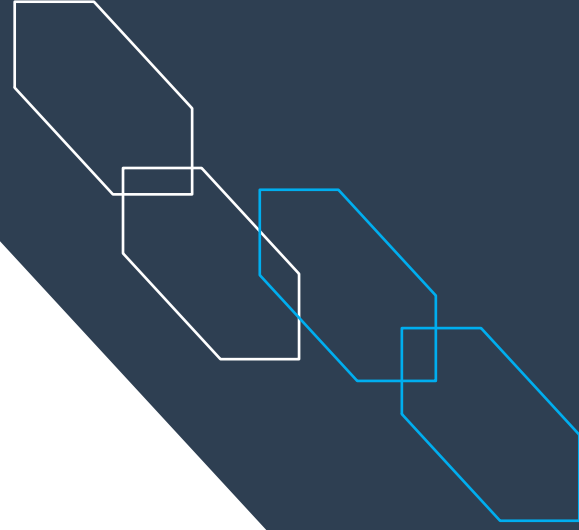

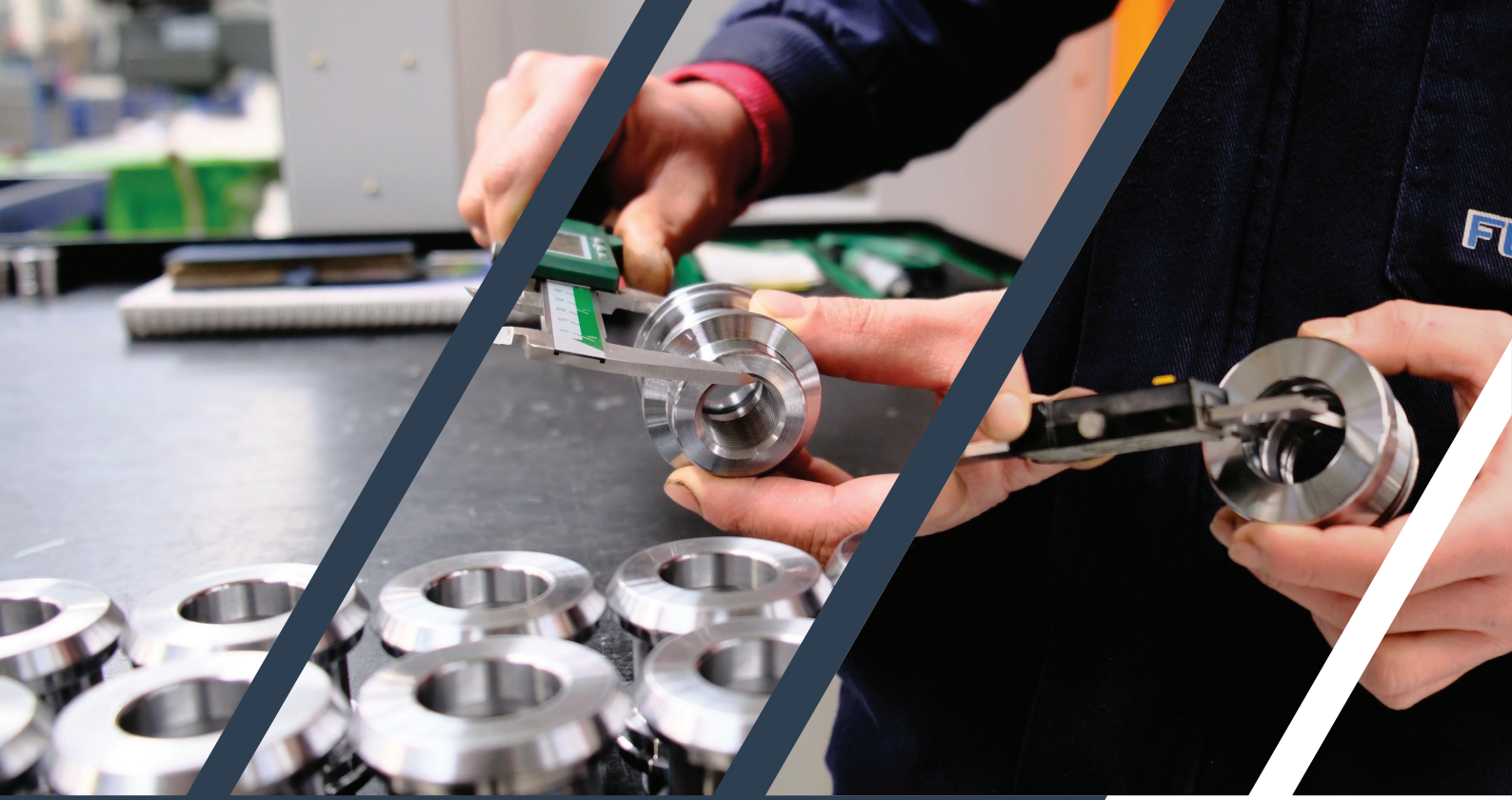

MİKRON HASSASİYETİNDE İŞLEME

MICRON
SENSITIVITY
PROCESSING



Teslim öncesi detaylı testler
Detailed tests before delivery

KALİTE DETAYDA GİZLİDİR.

QUALITY IS HIDDEN IN THE DETAIL.

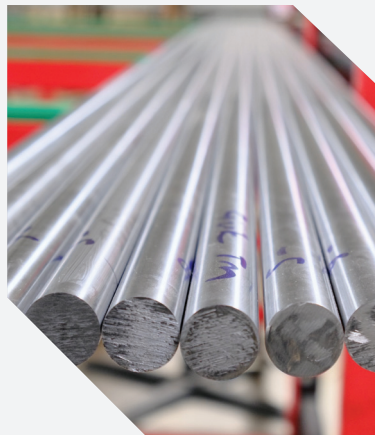

KROMLU MİLDE YAPACAĞIN EN DOĞRU HAMLE

WHAT YOU CAN DO IN A CHROME SHAFT
THE RIGHT MOVE



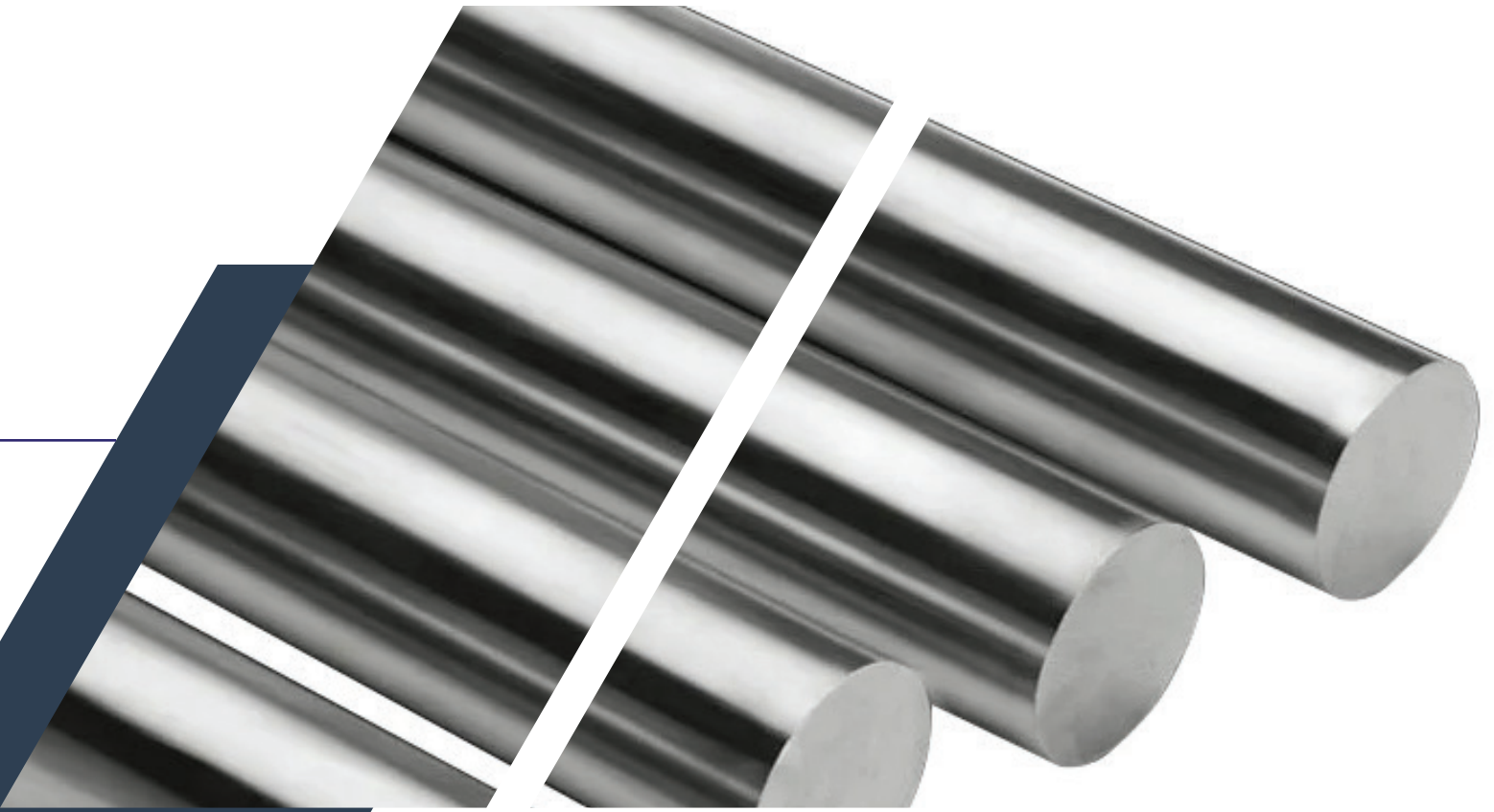

ÜRETİM BİZİM GENLERİMİZDE VAR...

PRODUCTION IS IN OUR
GENES...





**TEKNİK ÖZELLİKLER**

Stok Kodu	Ürün Cinsi	OEM
FHR-4703	HİDROLİK ORTA KOL ÇENGEL KANCASI	T480 - T480TD - 5092607
FHR-4704	ORTA KOL ASKI KİLİDİ (ZİNCİRLİ TAKIM)	TD SERİSİ - 47629893 - 48192851
FHR-4705	TRAKTÖR KUYRUK MİL FREZE UCU	-



TEKNİK ÖZELLİKLER			
Stok Kodu	Model	Ürün	Ağırlık (kg)
FHR-2200	DÜZ KRİKO	60X60	2000
FHR-2201	EKO- DÜZ KRİKO	60X60	2000
FHR-3000	DÜZ KRİKO	70X70	3000
FHR-3001	EKO- DÜZ KRİKO	70X70	3000
FHR-4000	DÜZ KRİKO	80X80	4000
FHR-4001	EKO- DÜZ KRİKO	80X80	4000

TEKNİK ÖZELLİKLER			
Stok Kodu	Model	Ürün	Ağırlık (kg)
FHR-2001	AYARLI KRİKO	60X60	2000
FHR-2002	EKO- AYARLI KRİKO	60X60	2000
FHR-3101	AYARLI KRİKO	70X70	3000
FHR-3102	EKO- AYARLI KRİKO	70X70	3000
FHR-4101	AYARLI KRİKO	80X80	4000
FHR-4102	EKO- AYARLI KRİKO	80X80	4000

TEKNİK ÖZELLİKLER			
Stok Kodu	Model	Ürün	Ağırlık (kg)
FHR-2003	ŞANZIMANLI KRİKO	60X60	2000
FHR-3003	ŞANZIMANLI KRİKO	70X70	3000
FHR-4002	ŞANZIMANLI KRİKO	80X80	5000
FHR-4003	ŞANZIMANLI KRİKO	100X100	8000



TEKNİK ÖZELLİKLER

Stok Kodu	Ürün Cinsi
RFS-01-01	19X125 MM ORTA KOL PİMİ
RFS-01-02	22X125 MM ORTA KOL PİMİ
RFS-01-03	25X125 MM ORTA KOL PİMİ
RFS-01-04	28X125 MM ORTA KOL PİMİ
RFS-01-05	19X125 MM ZİNCİRLİ PİM
RFS-01-06	22X125 MM ZİNCİRLİ PİM
RFS-01-07	25X125 MM ZİNCİRLİ PİM
RFS-01-08	28X125 MM ZİNCİRLİ PİM
RFS-01-17	25X150 MM ZİNCİRLİ PİM
RFS-01-09	19X150 MM ORTA KOL PİMİ
RFS-01-10	22X150 MM ORTA KOL PİMİ
RFS-01-11	25X150 MM ORTA KOL PİMİ
RFS-01-12	19X250 MM KIRMASIZ PİM
RFS-01-13	19X170 MM ORTA KOL PİMİ
RFS-01-14	22X170 MM ORTA KOL PİMİ
RFS-01-15	22X190 MM ORTA KOL PİMİ
RFS-01-16	22X220 MM ORTA KOL PİMİ



TEKNİK ÖZELLİKLER

Stok Kodu	Ürün Cinsi
RFS-02-01	25X180 MM REMORK ÇEKİ PİMİ
RFS-02-01-01	25X200 MM REMORK ÇEKİ PİMİ
RFS-02-02	28X180 MM REMORK ÇEKİ PİMİ
RFS-02-02-01	28X200 MM REMORK ÇEKİ PİMİ
RFS-02-03	30X180 MM REMORK ÇEKİ PİMİ
RFS-02-04	32X180 MM REMORK ÇEKİ PİMİ
RFS-02-05	34X180 MM REMORK ÇEKİ PİMİ
RFS-02-06	36X180 MM REMORK ÇEKİ PİMİ
RFS-02-07	25X250 MM REMORK ÇEKİ PİMİ
RFS-02-08	28X250 MM REMORK ÇEKİ PİMİ
RFS-02-09	30X250 MM REMORK ÇEKİ PİMİ
RFS-02-10	32X250 MM REMORK ÇEKİ PİMİ
RFS-02-18	19X180 MM REMORK ÇEKİ ZİNCİRLİ PİM
RFS-02-11	22X180 MM REMORK ÇEKİ ZİNCİRLİ PİM
RFS-02-12	25X180 MM REMORK ÇEKİ ZİNCİRLİ PİM
RFS-02-13	28X180 MM REMORK ÇEKİ ZİNCİRLİ PİM
RFS-02-14	30X180 MM REMORK ÇEKİ ZİNCİRLİ PİM
RFS-02-15	32X180 MM REMORK ÇEKİ ZİNCİRLİ PİM
RFS-02-16	34X180 MM REMORK ÇEKİ ZİNCİRLİ PİM
RFS-02-17	36X180 MM REMORK ÇEKİ ZİNCİRLİ PİM

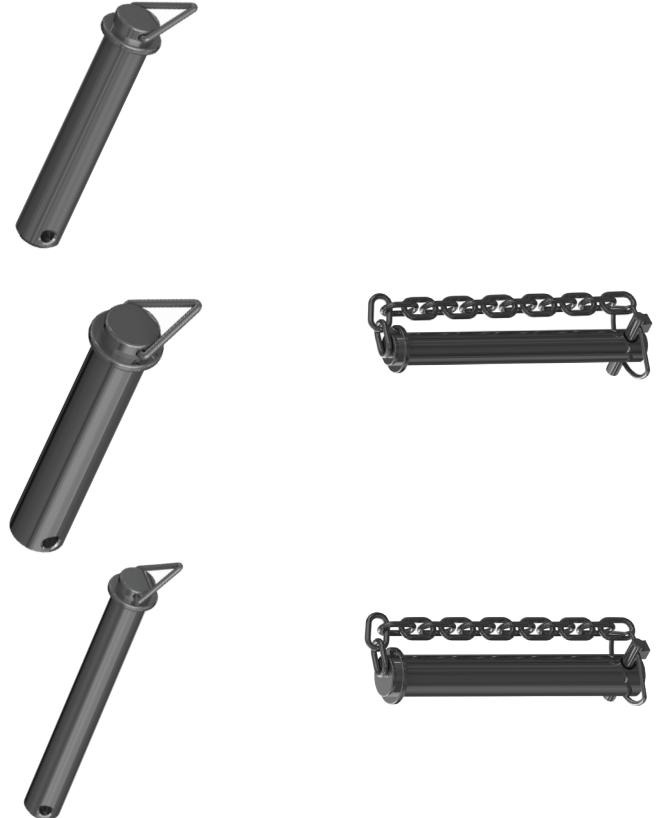

TEKNİK ÖZELLİKLER

Stok Kodu	Ürün Cinsi
RFS-05-01	28*28 PULLUK TİLLER PİMİ (SOMUNSUZ)
RFS-05-02	25*28 PULLUK TİLLER PİMİ (SOMUNSUZ)
RFS-05-03	22*28 PULLUK TİLLER PİMİ (SOMUNSUZ)
RFS-05-04	25*22 PULLUK TİLLER PİMİ (SOMUNSUZ)
RFS-05-05	25*25 PULLUK TİLLER PİMİ (SOMUNSUZ)
RFS-05-06	22*22 PULLUK TİLLER PİMİ (SOMUNSUZ)
RFS-05-07	25*28 KAZAYAĞI PULLUK TİLLER PİMİ (SOMUNSUZ)
RFS-05-08	28*28 KAZAYAĞI PULLUK TİLLER PİMİ (SOMUNSUZ)
RFS-05-09	22*19 MM (5/8) MİNİ TİLLER PİMİ KÜÇÜK TİP
RFS-05-10	22*19 MM (3/4) MİNİ TİLLER PİMİ BÜYÜK TİP



TEKNİK ÖZELLİKLER

Stok Kodu	Ürün Cinsi
RFS-07-01	12X45 MM TIRMIK PİMİ (EĞRİ BOYUN)
RFS-07-02	16X70 MM TIRMIK PİMİ (EĞRİ BOYUN)
RFS-07-03	16X90 MM TIRMIK PİMİ (EĞRİ BOYUN)
RFS-07-04	19X110 MM TIRMIK PİMİ (EĞRİ BOYUN)



TEKNİK ÖZELLİKLER

Stok Kodu	Ürün Cinsi
RFS-06-01	MF 135 16 MM*90 MM MF ASKI KOL PİMİ İNCE
RFS-06-02	MF 165 19 MM*90 MM MF ASKI KOL PİMİ ORTA
RFS-06-03	MF 285 22 MM*90 MM MF ASKI KOL PİMİ KALIN
RFS-06-04	22X65 MM FİAT ASKI KOL PİMİ 480-640 İNCE
RFS-06-05	25X65 MM MF ASKI KOL PİMİ 480-640 KALIN

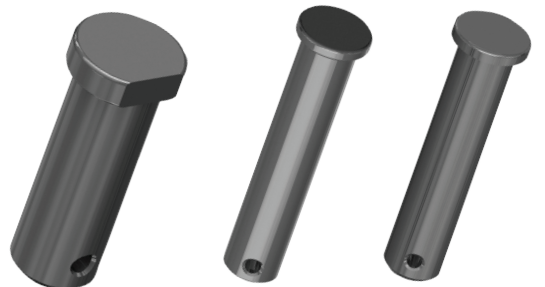



TEKNİK ÖZELLİKLER

Stok Kodu	Ürün Cinsi
RFS-04-01	640 ESKİ MODEL ŞAPKALI HİDROLİK KOL PİMİ
RFS-04-02	480 ESKİ MODEL ŞAPKALI HİDROLİK KOL PİMİ
RFS-04-04	640 SON MODEL 65/46 GÖVDE PERNOSU
RFS-04-05	480 SON MODEL 55/46 GÖVDE PERNOSU
RFS-04-06	640 YENİ MODEL HİDROLİK KOL PERNOSU
RFS-04-07	480 YENİ MODEL HİDROLİK KOL PERNOSU
RFS-04-03	70/56 GÖVDE PERNOSU
RFS-04-09	MF 285 ALT KOŞUM PİMİ



TEKNİK ÖZELLİKLER

Stok Kodu	Ürün Cinsi
RFS-03-01	19X220 MM MF KULAKLI ALT ÇEKİ PİMİ
RFS-03-02	19X250 MM MF KULAKLI ALT ÇEKİ PİMİ
RFS-03-03	19X300 MM MF KULAKLI ALT ÇEKİ PİMİ
RFS-03-04	19X350 MM MF KULAKLI ALT ÇEKİ PİMİ
RFS-03-05	FİAT LAMALI ORTA KOL (SEMER) PİMİ



4 KİTADA 50 ÜLKEYE ULAŞIYORUZ

WE REACH 50 COUNTRIES
IN 4 CONTINENTS





GLOBAL DÜŞÜNÜYORUZ

WE THINK GLOBAL



Pazarımız Yeryüzü...

Our Market is Whole Ground

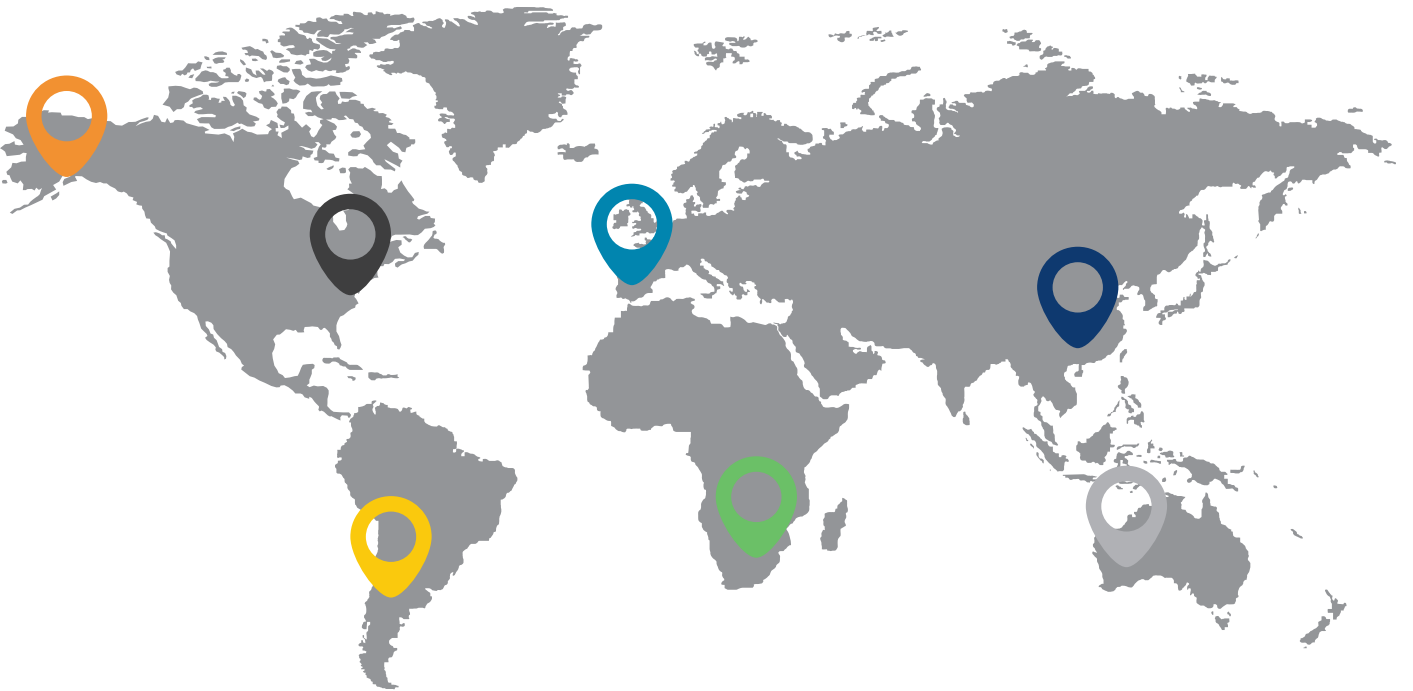

SEKTÖRÜN YÜKSELEN MARKASIYIZ

WE ARE THE RISING BRAND OF SECTOR

“ Kısa zamanda hızlı bir yükseliş grafiği sergiledik ve kurumsal yapımızı müşteri memnuniyetine dönüştürdük.”

“We have displayed a rapid upward trend in a short time and We transformed our corporate structure into customer satisfaction.”



KİTALARARASI UÇTUK

WE FLY
INTERCONTINENTAL



MÜŞTERİ ODAKLI
FİYAT UYGULADIK

CUSTOMER FOCUSED
WE APPLIED PRICE



GÜVEN KURDUK

WE ESTABLISHED
TRUST



SERVİS

SERVICE



GLOBAL

GLOBAL



AR-GE

R&D

Biz Profesyonellik ve Güçten Doğan Büyük Biz Aileyiz.

We are the Big Family,
Born of Professionalism
and Strength.



KURUMSAL

CORPORATE



ÇÖZÜM

SOLUTION



TEDARİK

SUPPLY



FÜHRER
GROUP

HYDRAULIC
LDR

HYDRAULIC
LEADER

 **CRMILL**

 **SETRAK**

FHR



HER SEKTÖRÜN
BİR ZİRVE NOKTASI VARDIR



FÜHRER İÇ VE DIŞ TİCARET LTD. ŞTİ.
Büyükkayacıoş Mah. 513 Nolu Sk. No: 12
5. Organize Sanayi Bölgesi Selçuklu / Konya / TÜRKİYE



T: +90(332) 342 43 23
+90(332) 503 17 20
F: +90(332) 503 17 21



E: harmankaya@fuhrer.com.tr



W: www.fuhrer.com.tr

